

**EagleBurgmann®**

Rely on excellence

# **Barrier/buffer media for mechanical seals**





On the following pages, basics, terms, and the purposes of barrier/buffer media are explained. This leads to the properties of the ideal barrier/buffer medium. Finally, standard barrier/buffer media are discussed and selected problematic cases are described.

Generally, it is not possible to make a global statement on the basis of this brochure as to whether or not a barrier/buffer medium is suitable for a mechanical seal. But the consequences and effects may be more easily evaluated, and an increase of the seal's life time may be achieved in specific applications.

### Purposes and function

If mechanical seals are used in pumps or other machines like mixers or dryers, often a barrier/buffer system with a suitable medium is necessary to cool and/or lubricate the seal or to avoid deposits. The external medium is named with the umbrella term 'barrier/buffer medium' and performs diverse tasks dependent on the application.

Barrier/buffer systems may be used in combination with single and multiple seals.

The barrier/buffer system takes over the heat removal or cooling in cases of high process temperatures, or high temperatures at the seal due to the dynamic friction of the seal faces.

If the process medium itself is not suitable for lubrication of the seal because of bad lubrication properties, or other reasons, for example high solid contents, then the barrier/buffer medium takes over the lubrication.

If the operating temperature is near the vapour point of the process medium, then there is an increased risk of evaporation in the sealing gap, and as a consequence dry running and destruction of the seal. The application of a barrier/buffer medium can avoid this.

Barrier/buffer media are also used if process media with a high solid content have to be sealed. Particles may enter the sealing gap which can lead to a destruction of the seal faces. Beyond this, solids may deposit inside the seal chamber thus blocking the o-ring's and the spring's movability.

Deposits at the atmospheric side of the seal occur if the process medium for example tends to crystallize or due to crack residues from oils.

In a lot of applications the process medium has to be completely separated from the environment. Possible reasons are, environmental hazards caused by the process medium, threat to safety in the workplace, or the process medium may not come into contact with oxygen.

Also heating of the seal by a barrier/buffer medium may be necessary if the process medium has a high melting point. Otherwise the process medium would harden at the atmospheric side and therefore lead to damages at the seal.





Selection of the correct sealing system requires the choice of a suitable barrier/buffer medium. The question of which barrier/buffer medium is the right one is therefore important, but not always easy to answer. The fact is that unsuitable barrier/buffer media may significantly reduce the life time of seals and have a negative effect on the process stream.

For the operator of the production plant, it is often not easy to find the right product. This brochure will help to evaluate the effects of barrier/buffer media on the life time of seals, and to choose a suitable medium taking into account the most important criteria.

Technical term (according to API 682*)	Description	Possible purposes
Quench	Introduction of an external medium on the atmospheric side of the mechanical seal.	■ ■ ■
Flush	Introduction of the process medium itself or an external medium into the stuffing box chamber in the area of the seal faces.	■ ■ ■
Buffer medium	Introduction of an external medium between two mechanical seals whereas the pressure of the buffer medium is below the pressure to be sealed.	■ ■
Barrier medium	Introduction of an external medium between two mechanical seals whereas the pressure of the buffer (barrier) medium is above the pressure to be sealed.	■ ■ ■ ■ ■

- Cooling of the seal
- Lubrication of the seal faces and therefore prevention of dry running
- Pressure increase in the sealing gap (increase of  $\Delta P$  to the vapour curve)
- Prevention of seal face destruction e.g. by solid particles
- Prevention of deposits in the area of the seal faces
- Prevention of deposits at the atmospheric side of the seal
- Complete separation of the process medium from the environment
- Heating of the seal due to process media with high melting point

\*) Standard of the American Petroleum Institute for refineries and similar applications.

The most important applications for barrier/buffer media and their purposes.

# Modes of operation and barrier/buffer systems

Depending on the design and the arrangement of the mechanical seal, and the required functions of the barrier/buffer system for the specific application, different modes of operation are possible or necessary. The plans for the auxiliary systems are based on the API 682.

## Quench

A quench according to API plan 51 or 62 means that mostly water or a gaseous medium like steam or nitrogen is used as external medium at atmospheric pressure.

## Flush

Flushing serves either to lower the temperature or to prevent deposits in the area of the seal faces. The flushing medium may be the process medium itself or an external medium. The most common API plans are 11, 21, 31 and 41. If an external medium is used then it is called API plan 32.

The flushing pressure has to be always higher than the pressure to be sealed. To restrict the flow of the flush into the process medium the flushing medium should be sealed against the impeller. This can be achieved by using a flow rate restrictor (throttle). The flow speed in the throttle gap should be between 1.0 and 2.5 m/s. Thus it is avoided that soiled product comes between the seal faces.

## Buffer and barrier medium

If an external medium is introduced between two mechanical seals two different pressure conditions are possible:

$p_3 < p_1$ : If the pressure of the external medium ( $p_3$ ) is lower than the pressure to be sealed ( $p_1$ ), then it is named a buffer medium (equivalent to API plan 52) or a buffer gas (equivalent to API plan 72).

$p_3 = p_0$ : If the pressure of the buffer medium is atmospheric pressure then this is called an unpressurized operation.

$p_3 > p_1$ : In case of a pressurized operation according to API plan 53 or 54 the external medium is called barrier medium or barrier gas with API plan 74.

In most cases it is recommended that the barrier pressure should be 2-3 bar (29-44 PSI) higher than the highest pressure to be sealed. In cases with operating pressures  $p_1 > 20$  bar (290 PSI) the barrier pressure should be 10 % higher than the pressure to be sealed.

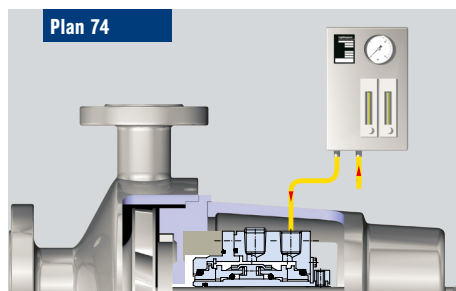
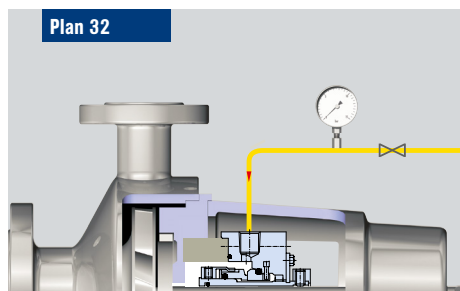
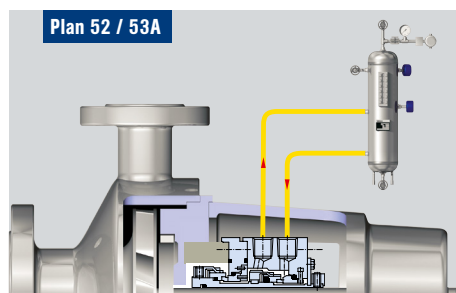
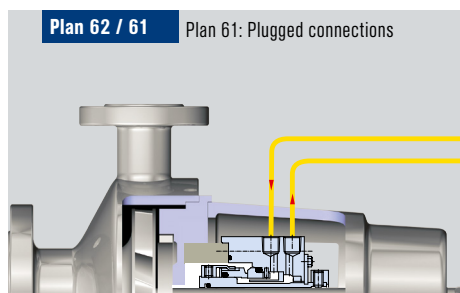

Detailed information on API is available in our brochure „API 682 4th edition Application guide“ Please ask for a copy.

Different values should be seriously challenged and matched with the relevant experts, if necessary. In case of vacuum operation higher differential pressures may be required after consulting EagleBurgmann.

If a quench or a buffer medium is used due to the pressure conditions, the quench medium is enriched with the process medium in the course of time. In case of a flush according to API plan 32, or a pressurized operation according to API plan 53 or 54, the pressure of the barrier medium is always higher than the operation pressure of the process medium to be sealed. The result is that the barrier medium is introduced into the process medium in a certain amount.

In a lot of cases a circulation of the barrier/buffer medium is required. This can be provided by a natural circulation by the thermosiphon effect, or by forced circulation using an integrated pumping device inside the seal, or a circulation pump. The circulating volume is dependent on different parameters like the type of circulation, the rotational speed, or the viscosity of the used barrier/buffer medium.

## Barrier/buffer systems

Barrier/buffer systems can be divided into pressureless and pressurized systems. Examples for such systems are displayed on this page.

During the installation some general things have to be considered:

- Assembly and operating manual of the barrier/buffer system.
- The installation of the barrier/buffer system should provide an easy operation, monitoring and maintenance.
- The tank should be positioned above the mechanical seal (approximately 1 ... 2 m) to allow a natural circulation of the barrier/buffer medium. The distance may be shorter if the circulation is supported by a pumping device inside the seal or a circulation pump.
- The piping of the barrier/buffer system loop should be made of stainless steel and the dimensions should be according to the assembly and operating manual. The pipe sections are normally connected by screwed joints.

- The arrangement of the piping should be as short and streamlined as possible. To avoid air pockets the pipes should be installed steadily rising. To change the direction, only pipe bends and for shut-offs, ball valves with full bore should be used.
- In principle the outlet pipe of the mechanical seal has to be connected with the lateral connection of the barrier/buffer system tank. Please carry out the following instructions for the connection:
  - Mechanical seal OUT has to be connected with barrier/buffer system IN,
  - Barrier/buffer system OUT has to be connected with mechanical seal IN.



EagleBurgmann TS2000 seal barrier/buffer system, displayed with circulation pump SPU 5000. Equipped with all necessary connections for additional measuring units.

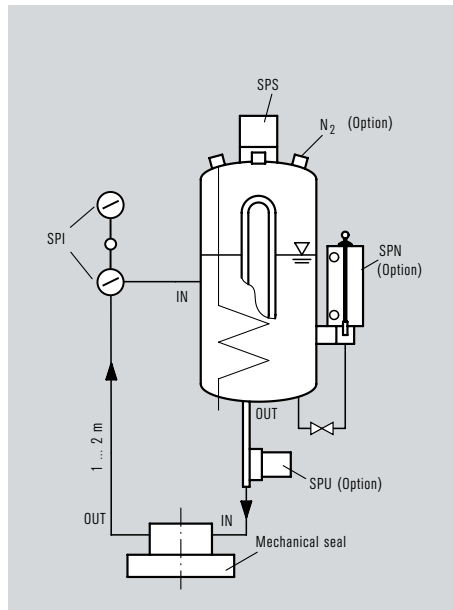

Pressurized thermosiphon system for natural or forced circulation.

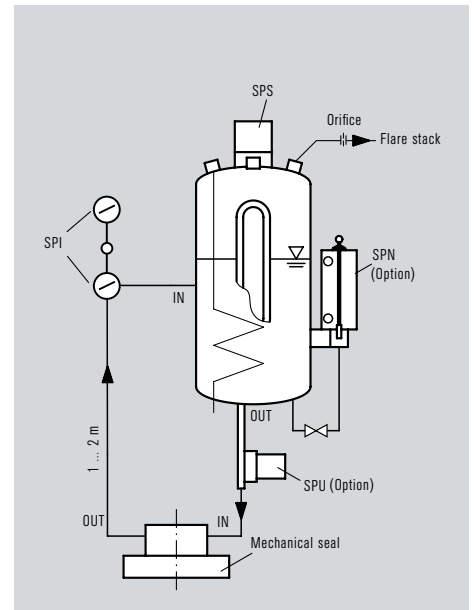

Pressureless thermosiphon system for natural or forced circulation.



# The ideal barrier/buffer medium

The demands on the "ideal" barrier/buffer medium are sophisticated and it is difficult to always fulfill all criteria. Therefore each decision is characterized by setting priorities and making compromises. Mainly the following criteria are important to select a suitable barrier/buffer medium:

- High lubrication capacity
- High heat capacity
- Free of solids
- No tendency to deposit
- High resistance of the used materials
- High ageing resistance
- Suitable viscosity
- Good compatibility with the process medium
- No classification as hazardous substance
- High ignition temperature and high flash point
- Sufficient distance between the boiling point and the process temperature
- No tendency to foam
- Good availability and low costs



Cartex-DN double mechanical seal with connections and integrated pumping device. The viscosity of the barrier/buffer medium is recommended to be max. ISO VG 5.

## General demands

One of the primary tasks of a barrier/buffer medium is the lubrication of the seal faces. Consequently the barrier/buffer medium should have a high lubrication capacity. In most cases the lubricity of water is sufficient. Also, a high heat capacity has advantages if the barrier/buffer medium is used for cooling the seal, because the heat capacity is proportional to the heat removal. The heat capacity of the barrier/buffer medium has to be considered during the dimensioning of the barrier/buffer system to calculate the required circulation rate for example.

The barrier/buffer medium may neither contain solids nor tend to build up deposits. Deposits or smears may occur, for example, due to crack residues of oils, or due to residue building additives in oils, particularly zinc or phosphor additives or silicates. For this reason also media which tend to crystallize should not be used.

The materials of the barrier/buffer system have to be resistant against the barrier/buffer medium. For example if EPDM elastomers are used, no oil may be used as barrier/buffer medium.

Important is also the high ageing resistance which means the barrier/buffer medium should not change its properties even after time. This may happen by the influence of temperature or shear stress, by contact with air (oxidation reactions, cracking, formation of acids, polymerisation) or humidity (hydrolysis, formation of acids).

## Heat capacity

	spec. heat capacity at 20 °C (68 °F) [kJ/(kg·K)]	Thermal conductivity at 20 °C (68 °F)[W/(m·K)]
"normal" water	4.3	0.6
30 % propylene glycol/70 % water	3.95	0.47
oil	~2	~0.1
silicone oils	1.45	~0.15
glycerine	2.4	0.3
ethanol	2.4	0.17
air	1	0.026
nitrogen	1	0.026

Oil and other hydrocarbons have about half of the heat capacity of water.

Specific heat capacities and thermal conductivities of typical media

## Viscosity

Low viscosity fluids are generally more suitable to be used as barrier/buffer medium than fluids with a high viscosity. The higher the operational demands on the seal regarding rotating speed and heat generation the lower the viscosity has to be. In exceptional cases higher viscosities may be required. This has to be checked on an individual basis.

The viscosity is dependent on temperature and decreases with increasing temperature and vice versa. Therefore the viscosity index of the barrier/buffer medium should be as high as possible, which means the temperature dependence of the viscosity should be as low as possible. Depending on operation mode of the mechanical seal, the following recommendations regarding the optimal viscosity of the barrier/buffer medium can be given. Preferably it should be observed within the whole operating temperature range.

- Natural circulation: 0.5 to 5 mm<sup>2</sup>/s;
- Forced circulation by a pumping device inside the mechanical seal: 0.5 ... 12 mm<sup>2</sup>/s;
- Forced circulation by an external circulation pump: 0.5 ... 15 mm<sup>2</sup>/s.

A pumping device inside a mechanical seal may be a pumping screw or a pump ring. Here the performance curve has to be considered because it is dependent on the viscosity. Seals with different pump devices like the EagleBurgmann Cartex have to be examined separately.

If an external pump is used for the circulation its design data has to be observed. For example, if an EagleBurgmann SPU500 is used the maximum allowable viscosity is 15 mm<sup>2</sup>/s.

If a gear pump is used in an EagleBurgmann SPA, a pressurized barrier fluid system, the viscosity within the whole operating temperature range has to be 12 mm<sup>2</sup>/s minimum.

In exceptional cases, for example, with compressors or agitators, higher viscosities (up to 68 mm<sup>2</sup>/s) may be used. But this always has to be checked with the relevant experts.

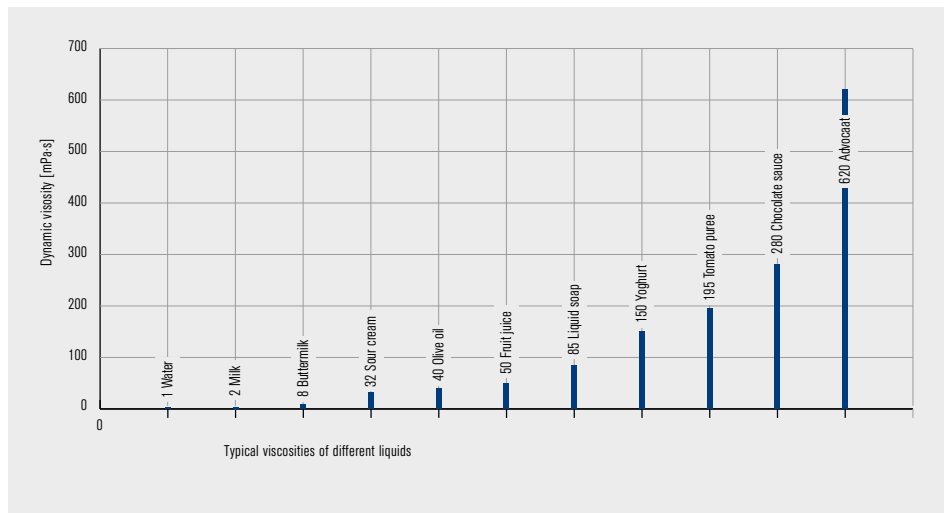

## Viscosity

The viscosity describes the "thickness" of liquids and melts, but also of suspensions. It is a measure of the fluid's internal resistance to flow and is defined by the frictional resistance with which a fluid responds to deformation by compressive or shear stress. The higher the viscosity the "thicker" the fluid and the lower the capability of flow. There are two related measures of fluid viscosity – known as dynamic and kinematic viscosity. The dynamic viscosity is the ratio of shear stress and the velocity gradient vertical to the flow direction. It can be defined by the force  $F$  to move 2 parallel planes with the velocity  $v$  against each other. In most cases it is measured with rotation viscometers.

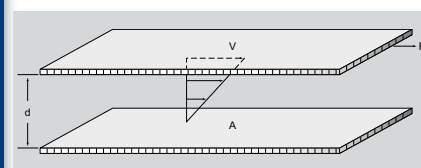

Graphical illustration of the dynamic viscosity.

Source: Römpp Lexikon

The current unit of dynamic viscosity  $\eta$  is mPa·s. In earlier times the unit P (Poise) or cP (Centi poise) was used. 1 cP = 1 mPa·s. Water has a viscosity of 1 mPa·s at 20 °C (68 °F).

The kinematic viscosity  $\nu$  is a measure of the internal friction in a fluid. It is measured for example with a capillary or falling sphere viscometer, or it is calculated by dividing the dynamic viscosity by the density of the liquid:  $\nu = \eta / \rho$

Today the common unit of the kinematic viscosity  $\nu$  is mm<sup>2</sup>/s. In earlier times the unit St (Stokes) or cSt (centi Stokes) was used. 1 cSt = 1 mm<sup>2</sup>/s.

Specialities regarding the viscosity are non-Newtonian fluids. In contrast to Newtonian fluids these fluids change their viscosity with the applied strain rate. As a result, non-Newtonian fluids may not have a well-defined viscosity. Examples for non-Newtonian fluids are blood, cement glues, quicksand, sand-water-mixtures, starch-water-mixtures, lubricants, polymer melts, ketchup and pudding. Depending on their properties change by the applied shear rate, non-Newtonian fluids may be divided into pseudoplastic fluids (viscosity is reduced with shear rate) and dilatants (viscosity is increased with shear rate).

Non-Newtonian fluids should not be used as barrier/buffer medium for mechanical seals because their properties change when shear forces are applied. This may have negative effects on the life time of the mechanical seal.





## Compatibility with the process medium

The compatibility of the barrier/buffer medium with the process medium has to be checked together with the end user in each case. The barrier/buffer medium should be inert against the process medium, which means no reaction can take place between the barrier/buffer medium and the process medium at the corresponding operating conditions.

Also the quality of the process medium must not be negatively influenced by the barrier/buffer medium. This is of particular importance with end products such as, food, cosmetics and pharmaceuticals.

If necessary specific regulations like the German "Regulation about the use of extraction solvents and other auxiliary materials in the production of food", the German food and feed code „Lebensmittel- und Futtermittelgesetz (LFGB)“ and specific "Codes of federal regulations" (CFR) of the food & drug administration (FDA) have to be considered. The evaluation whether a medium can be used as barrier/buffer medium in the food and pharmaceutical industry has to be done by the operator of the seal.

On the strength of past experience barrier/buffer media which are certified according to USDA-H1 or NSF/H1 (USDA = United States Department of Agriculture, NSF = National Sanitary Foundation) can be used. Probably media which are approved according to CFR 172: "Food additives permitted for direct addition to food for human consumption" or CFR 178: "Indirect food additives: adjuvants, production aids, and sanitizers" may also be used.

### Documents to evaluate the barrier/buffer medium with regard to environmental hazard, health hazard and security aspects (safety in workplace):

- Material safety data sheet
- Technical instructions on air quality control – "TA-Luft"
- GESTIS database on hazardous substances (Information system on hazardous substances of the German Social Accident Insurance)
- Appendix VI of the regulation (EC) no. 1272/2008, tables 3.1 and 3.2 (list of harmonized classification and labelling of hazardous substances).
- European chemical Substances Information System (ESIS)

## Security aspects

In principle the evaluation of the barrier/buffer medium regarding environmental hazard, health hazard and security aspects (safety in the work place) has to be done by the operator of the seal. The used barrier/buffer medium should not be classified as a hazardous substance, thus it should neither be harmful to health nor to the environment. The ignition temperature of the barrier/buffer medium should be significantly higher than the maximum operating temperature. Low flammability is a further criterion: the flash point should be significantly higher than the maximum operating temperature. The formation of explosive or ignitable mixtures with air has to be avoided in all cases. The maximum operating temperature should be at least 40 °C (104 °F) lower than the boiling point of the barrier/buffer medium. If the seal is only low stressed, which means low pressure, low sliding velocity and low temperature, a lower temperature difference of e.g. 20 °C (68 °F) may be sufficient. This has to be clarified on an individual basis.

### Ignition temperature and flash point

The ignition temperature is the lowest temperature of a hot surface at which substances self ignite. According to this, the ignition temperature is the lowest temperature which flammable gases, vapours, dusts or finely dispersed solids must have in the most ignitable mixture with air to initiate the combustion or the explosion. It is not a material constant but dependent on the test conditions.

The flash point is the lowest temperature, corrected to a pressure of 101,3 kPa (760 Torr), at which the vapours can be ignited by an ignition source under specified test conditions.

Source: Römp Online Lexikon



## Gas solubility, foaming

Increased gas content in the barrier/buffer medium has a negative impact on the seal and has to be avoided. Also foaming is problematic in combination with a barrier/buffer medium.

Generally the gas solubility of liquids increases with rising pressure and decreasing temperature. Dissolved salts decrease the solubility of gases. Due to the lower density and the centrifugal forces the dissolved gas (e.g. air, nitrogen) accumulates at the smallest diameter and thus can not escape. This may lead to a ring of gas in the seal gap and thus leads to dry running and destruction of the seal faces. The degassing of the medium may be mainly a problem in pressurized operation with the usage of a thermosiphon vessel where nitrogen is used to create the pressure in the barrier system: in this case nitrogen can dissolve in the barrier fluid and degas inside the seal. Therefore it is recommended to limit the maximum barrier pressure in combination with thermosiphon systems to 20 bar (290 PSI).

Foaming of the barrier/buffer medium may occur if air degasses in a liquid but does not collapse at the surface. This may have different reasons, e.g. high content of additives in oils, impurities or leak air.

### Henry's law

$$C_i = \alpha_{ij} \cdot p_i$$

$C_i$  = concentration of gas in liquid

$p_i$  = partial pressure of the gas above the liquid

$\alpha_{ij}$  = temperature dependent solubility coefficient of the gas i in liquid j  
(= Bunsen absorption coefficient or Bunsen coefficient)

The amount of gas which is dissolved in a liquid is proportional to its partial pressure at the liquid surface (at equilibrium). At equilibrium means the liquid is saturated. Only at high pressures there will be a difference in proportionality.

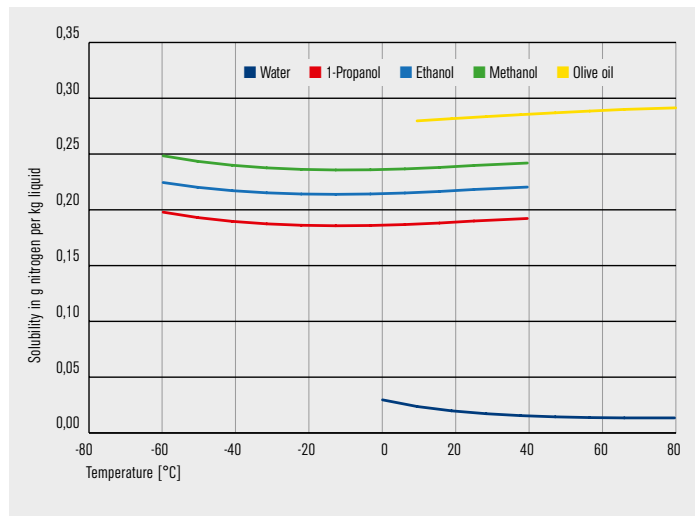

The solubility of nitrogen in liquids at atmospheric pressure

Source: The solubility of nitrogen and air in liquids, J. Phys. Ref. Data, Vol. 13, No. 2, 1984

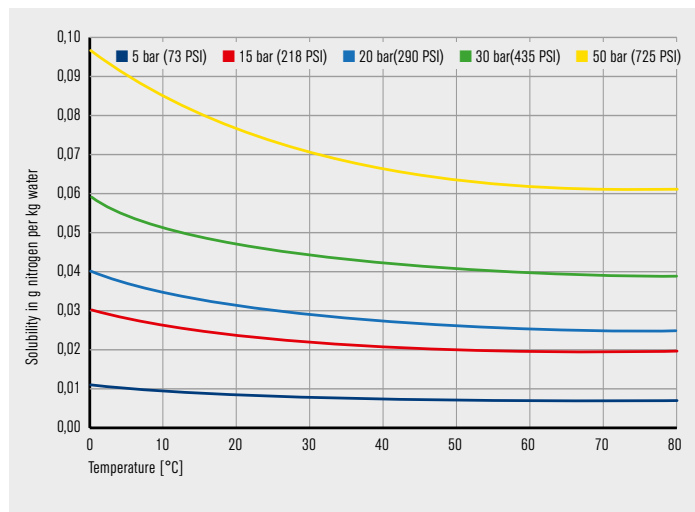

The solubility of nitrogen in water dependent on pressure

Source: The solubility of nitrogen and air in liquids, J. Phys. Ref. Data, Vol. 13, No. 2, 1984

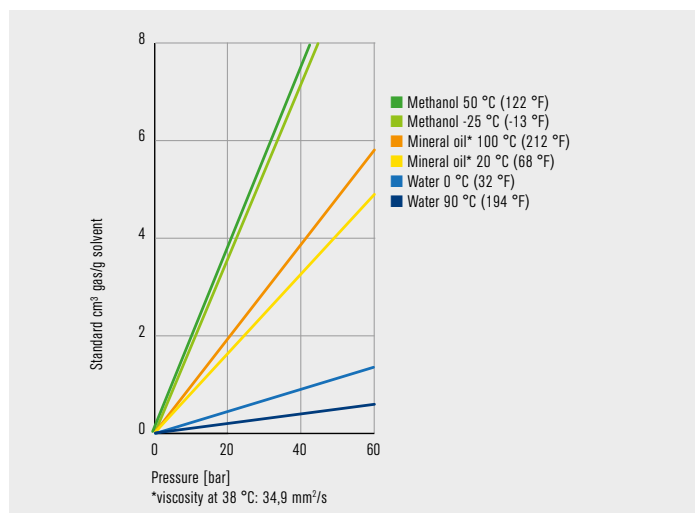

The solubility of nitrogen in liquids dependent on pressure

# Standard barrier/buffer media

In this chapter detailed information about standard barrier/buffer media is provided and existing problems are described.

Barrier/buffer media which are often used:

- Water
- Mixtures of water-glycol
- Alcohols
- Different oils like mineral oils, synthetic oils, white oils or vegetable oils
- Gaseous media like nitrogen or steam

**Water with the following properties is suitable as barrier/buffer medium.**

- $6.5 \leq \text{pH-value} \leq 7.5$
- $25 \mu\text{S/cm} \leq \text{conductivity} \leq 250 \mu\text{S/cm}$
- Total dissolved solids (TDS)  $\leq 500 \text{mg/l}$
- Hardness of water  $\leq 100 \text{ppm CaCO}_3$  ( $\approx 5.6 \text{ }^\circ\text{dH}$ )
- $60 \text{ mg/l CaCO}_3 \leq \text{Alkalinity} \leq 150 \text{ mg/l CaCO}_3$  (ideal is between 80 and 120 mg/l  $\text{CaCO}_3$ )
- no solids
- Turbidity  $< 5 \text{ NTU}$
- Chloride content  $< 250 \text{ ppm}$
- $0 \leq \text{LSI (Langelier saturation index)} \leq +0.5$
- Free of gas, which means  $\leq 0.2 \text{ Ncm}^3 \text{ dissolved gas per cm}^3 \text{ of water}$

In general distilled or demineralized water fulfill these criteria.

## Water

In a lot of cases water is a suitable barrier/buffer medium. In most of the cases demineralized water or distilled water can be used. Because the lubrication characteristics of these water qualities are quite bad the suitability has to be checked with an expert from EagleBurgmann in case of hard/hard seal face combinations and high operational demands on the seal.

Make sure that the temperature at the seal outlet does not exceed  $60 \text{ }^\circ\text{C}$  ( $140 \text{ }^\circ\text{F}$ ). On the one hand a sufficient distance to the boiling point has to be ensured and on the other hand the deposition of calcium carbonate should be kept on a low level. The water should not contain any solids as they tend to deposit (calcium carbonate). The deposition of calcium carbonate is mainly problematic at the atmospheric side of the seal due to the vaporisation of the leakage. This may lead to clogging of the dynamic O-ring.

The decision tree below can be used to evaluate the quality parameters of water which should be used as barrier/buffer medium. The surrounding conditions, mainly the temperature play a decisive role.

Some of the parameters interact in their effects thus if only one parameter is given the evaluation of the water quality is not possible. Therefore the saturation index (also Langelier saturation index, LSI) was established which describes the tendency of water regarding calcium carbonate deposition.

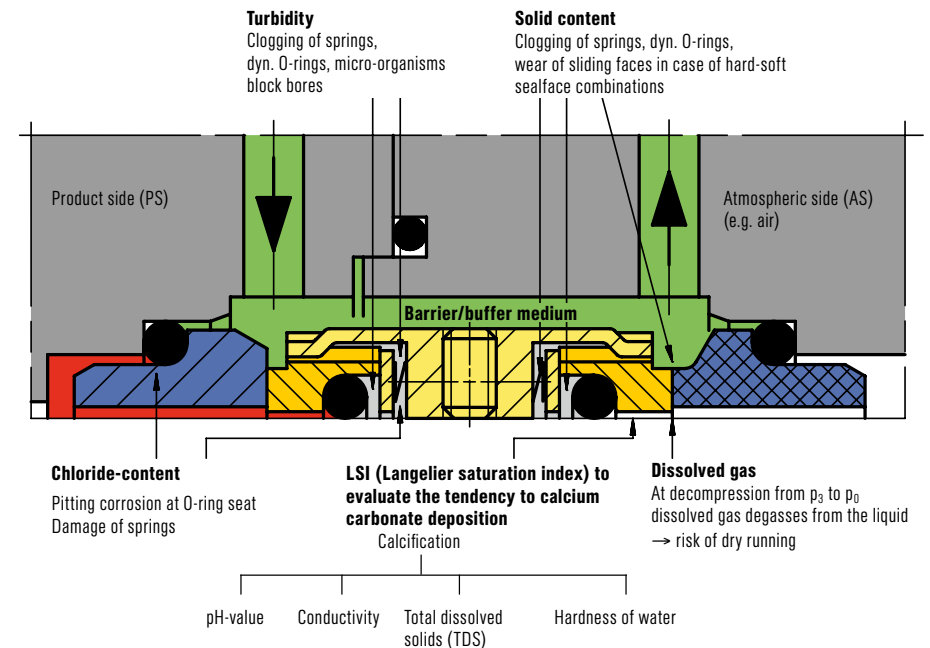
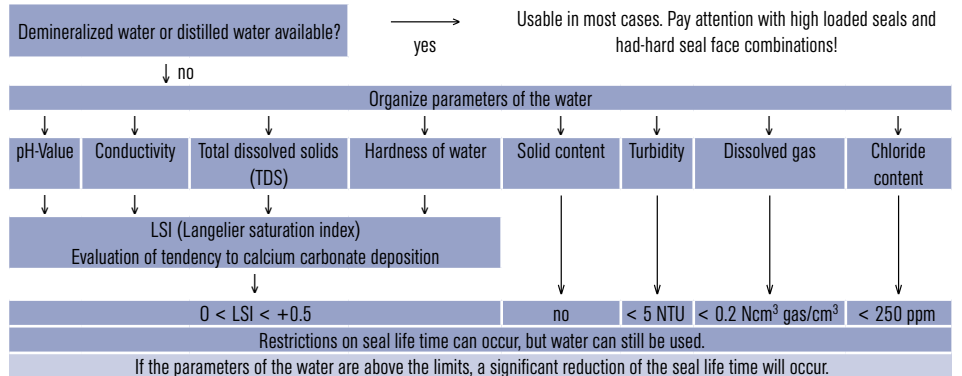

Effects of the water quality on the function of a mechanical seal



The Langelier saturation index can be calculated on the basis of a water analysis, e.g. with the LSI-calculator from EagleBurgmann.

$$LSI = pH - pH_s$$

$$pH_s = f(TDS, T, c(CaCO_3), A)$$

- TDS = Total dissolved solids in mg/l
- T = Temperature in °C
- c(CaCO<sub>3</sub>) = Concentration of calcium carbonate (CaCO<sub>3</sub>) in mg/l
- A = Alkalinity (measured as CaCO<sub>3</sub> in mg/l)
- pH = pH-value of the water

The alkalinity describes the capacity of water to neutralize acids. It is measured in mg calcium carbonate per liter of water (mg/l CaCO<sub>3</sub>). If the alkalinity is not known the following assumption may be made (However this is only an approximation and therefore imprecise):

$$\text{Alkalinity (mg/l CaCO}_3\text{)} = \text{Carbonate hardness (mg/l or ppm)} \cdot 0.7$$

Typically calcification occurs under the following conditions:

- Hardness > 100 ppm CaCO<sub>3</sub> ≈ 5.6 °dH ≈ 1 mmol/l
- TDS > 1000 ppm and
- pH > 7.5

However the temperature of the water plays a decisive role and has to be considered. The tendency of calcium carbonate deposition increases with increasing temperature. Indeed there are possible measures to influence the calcification:

- Demineralization by reverse osmosis, distillation or de-ionization. With the aid of these water treatment methods the dissolved minerals are removed from the water and thus the total dissolved solids (TDS-value) will be reduced.
- Water softening by using additives or ion exchangers. Thereby the calcium and magnesium concentration in the water will be reduced.
- Acidification of the water by using e.g. citric acid. The pH-value should not fall below 6.
- Avoidance of high temperatures

### Comparative table for hardness values

If the total hardness is known but not the calcium hardness it can be assumed that the measured hardness comes from calcium carbonate ("worst case"). Then calcium hardness = total hardness.

German degree of hardness [°d]	Alkaline earth metal ions [mmol/l]	Alkaline earth metal ions [mval/l]	Engl. degree of hardness [°e]	French degree of hardness [°f]	ppm CaCO <sub>3</sub> [°US]
1	0.2	0.4	1.3	1.8	17.8
3	0.5	1.1	3.8	5.3	53.4
5	0.9	1.8	6.3	8.9	89.0
8	1.4	2.9	10.0	14.2	142.4
10	1.8	3.6	12.5	17.8	178.0
13	2.3	4.6	16.3	23.1	231.4
15	2.7	5.4	18.8	26.7	267.0
18	3.2	6.4	22.5	32.0	320.4
20	3.6	7.1	25.0	35.6	356.0
25	4.5	8.9	31.3	44.5	445.0
30	5.4	10.7	37.5	53.4	534.0

1 German degree of hardness [°d] is equal to 10 mg CaCO<sub>3</sub> per 1000 ml of water



Agitator seal with TS-system

## Water-glycol mixtures

are mixtures of water and ethylene or propylene glycol. Further additives should not be used. Water with cooling agents like antifreeze or corrosion inhibitors, heat transfer media and cooling brines are not suitable.

Propylene glycol should be preferred because ethylene glycol has a health hazard potential and is subject to the classification according to the EC-regulation of hazardous substances.

Typically, mixtures of about 30 % glycol and 70 % water are used as barrier/buffer medium. Mixtures with a glycol content of more than 50 % should not be used because the viscosity significantly increases with increasing glycol content. The advantage of mixtures of water-glycol over water is the considerably lower freezing point.

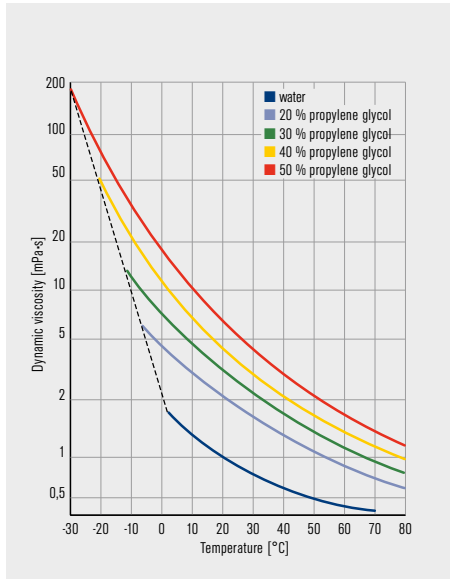

Dynamic viscosity of water-propylene glycol mixtures  
Source: Internet, Pekasol L Data sheet, pro Kühleisole GmbH

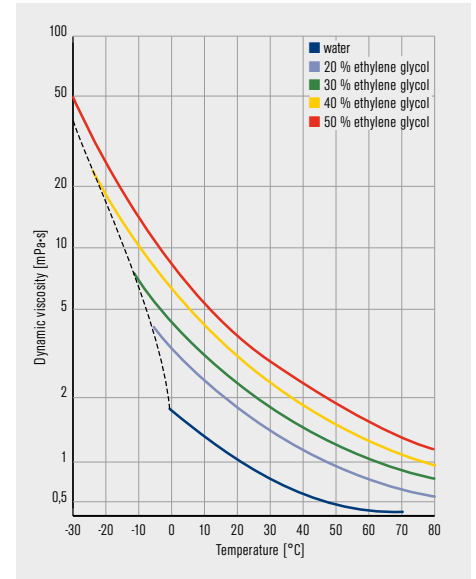

Dynamic viscosity of water-ethylene glycol mixtures  
Source: Internet, Glykosol N Data sheet, pro Kühleisole GmbH

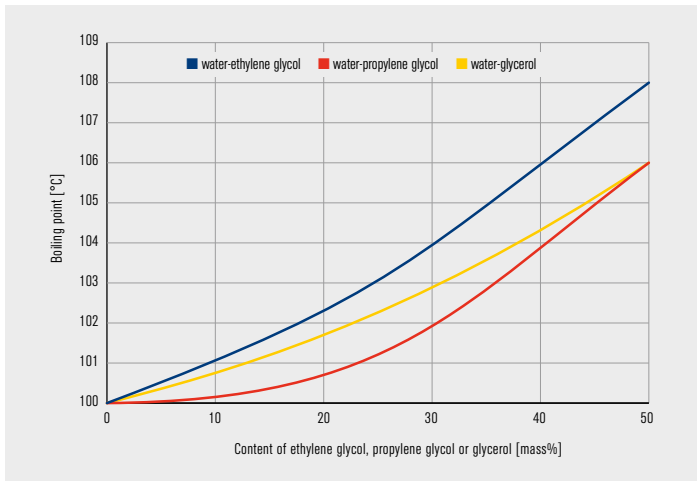

Boiling points of water-ethylene glycol, water-propylene glycol and water-glycerol mixtures  
Source: Internet, pro Kühleisole GmbH

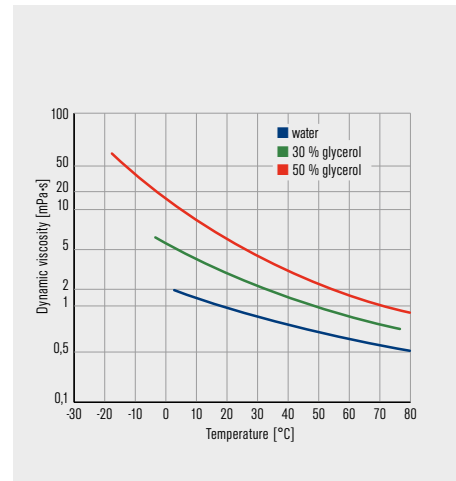

Dynamic viscosity of water-glycerol mixtures  
Source: Ullmann's Encyclopedia of Industrial Chemistry, paper Glycerol



Freezing points of water-ethylene glycol, water-propylene glycol and water-glycerol mixtures  
Source: Internet, pro Kühleisole GmbH



Specific heat capacity of water-ethylene glycol, water-propylene glycol and water-glycerol mixtures  
Source: Internet, pro Kühleisole GmbH



## Alcohols

Preferred barrier/buffer media, including for food and pharmaceutical applications, are the alcohols ethanol or propanol. Also mixtures with water are possible. Most of the alcohols, mainly the alcohols with lower molecular mass are volatile substances, which means that they evaporate fast at atmospheric conditions. This will cause a number of disadvantages. On the one hand the barrier/buffer medium often has to be refilled, mainly if used as unpressurized buffer medium and on the other hand ignitable mixtures with air may form more easily.

An advantage of most alcohols is the low melting point of significantly below 0 °C (+32 °F). Therefore alcohols are preferred in low temperature applications. Ethanol has a melting point of -114.5 °C (238.1 °F) and a boiling point of 78.3 °C (172.9 °F). The melting point of propanol is -126 °C (-195 °F) and the boiling point 97 °C (207 °F). Due to their high vapour pressure, in Germany the TA-Luft has to be considered. Possible alternative alcohols may be 1-butanol or 2-methyl-1-propanol, but they are classified as harmful.

Glycerol (=propanetriol) is another alcohol which is used in mixtures with water as barrier/buffer medium preferred for food and pharmaceutical applications. At room temperature glycerol is a colourless, odourless, viscous and hygroscopic liquid which is well miscible with water. The melting point is quite high at about 18 °C (64 °F), the viscosity at room temperature 20 °C (68 °F) is 1,500 mPa·s.

## Oils

If oils are used as barrier/buffer medium the following things have to be considered: If they are exposed to higher temperatures for any length of time their properties may negatively change. A lot of oils, mainly mineral oils, build up residues similar to lacquer or glue up to tar, at higher thermal stress. This happens due to a partial decomposition of the base oil which is not very thermostable. A maximum temperature of 60 °C (140 °F) at the outlet of the seal is recommended.

In general oils may only be used within the specified service temperature range for oxygen atmosphere according to the manufacturer. If oils are used as barrier/buffer medium their hygroscopicity may be a problem. The water content may be up to 1,500 ppm whereas the lubrication capacity drastically decreases at water contents  $\geq 750$  ppm.

Mineral oils often contain additives, e.g. to improve the corrosion protection or the ageing stability. These additives may thermally decompose and form deposits on the seal faces, which may lead to a destruction of the seal faces.

This problem is known for example with the additive ZnDTP (Zinc dithiophosphate) because ZnDTP decomposes at about 120 °C (248 °F).

Please also make sure that no ash is used as additive. The dependence of the viscosity on the temperature should be as low as possible, which means the viscosity index (VI) should be as high as possible. In general, synthetic oils have a higher viscosity index than mineral oils.

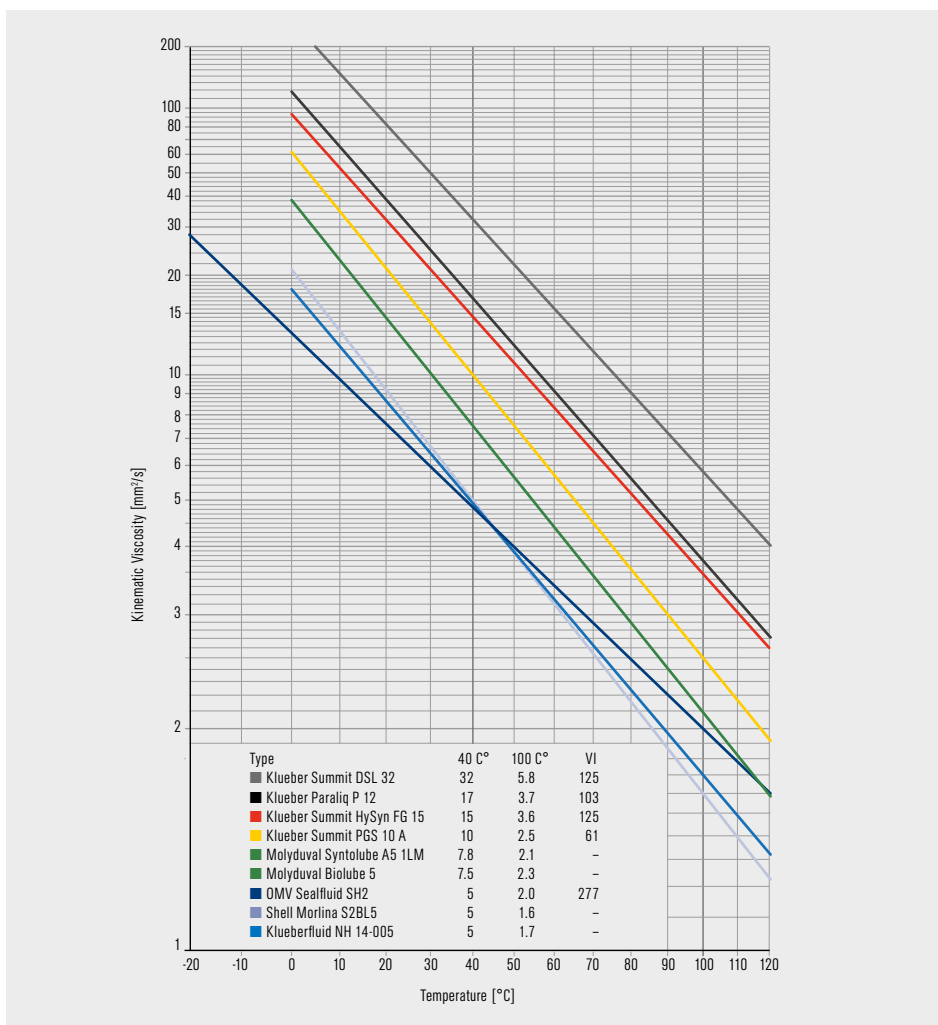

Viscosity-Temperature (VT)-Diagram of different oils  
Source: Manufacturer information

## Mineral oils

Often so called lubricating oils are used as barrier/buffer media. They are composed of the high boiling fractions of the raw oil and are separated by vacuum distillation, de-paraffinized and de-aromatized. At the end high quality products are treated with hydrogen under pressure to eliminate impurities. Thus the base oils are produced. The properties of the end product (motor oil, gear oil, electrical insulating oil, metal working oil, hydraulic oil etc.) are adjusted by blending oils with different properties and by selecting suitable additives.

Lubricating oils are classified in viscosity classes according to the ISO-VG (International organisation for standardization – Viscosity Grade). The labelling shows the viscosity at 40 °C (104 °F). Example: ISO VG 5 -> ~5 mm<sup>2</sup>/s at 40 °C (104 °F).

In many cases also hydraulic oils are used as barrier/buffer medium. These are operating liquids used for hydrostatic and hydrodynamic transmission of power. The labelling shows which additives were added.

Compressor oils are an additional group of mineral oils which are often used as barrier/buffer medium. They are highly raffinated mineral oils and therefore of higher thermal stability than “standard” mineral oils. They are used to lubricate fast running bearings and gears installed in turbo compressors and steam turbines. Oils for this use are specified in the DIN 51515. However, compressor oils are not suitable for high sliding velocities (>100 m/s), because they form deposits or smears on the sliding faces.

Good experiences exist with the oils „Shell Morlina S2BL5 and S2BL10“ and “Aral Vitam AC”, which have proven themselves as barrier fluids used on several test rigs.

A further recommendation is “Klüber Paraliq P 12”, a paraffin type mineral oil:

- Certified according to NSF-H1, which means that it may be used in food and pharmaceutical applications
- Operating temperature range: -10 °C ... +60 °C (14 °F ... 140 °F)
- Kinematic viscosity: 20 mm<sup>2</sup>/s at 40 °C (104 °F) and 3.7 mm<sup>2</sup>/s at 100 °C (212 °F)
- Neutral towards numerous HNBR- and FKM elastomers

## White oils

are a group of oils which are often used as barrier/buffer medium. They are high-value lubricants which are synthesized out of paraffinic oils. They may be classified in technical and extra high-quality medical white oils.

Technical white oils are very stable regarding environmental influences and gum formation and they do not get rancid. Medical white oils are used in pharmaceutical, food and cosmetic applications and have to fulfil high quality standards regarding purity and compatibility. Therefore these medical white oils are colourless, odourless and tasteless and they are aromatic and sulphur free.

Due to their limited temperature stability the maximum outlet temperature of the barrier/buffer medium is recommended not to exceed 60 °C (140 °F). Good experiences exist for example with Biolube 5 from Molyduval.

## Vegetable oils

The advantage of vegetable oils as barrier/buffer medium is their good biodegradability. Beyond this they are easy available and may be used in the food industry. However vegetable oils have a relatively low resistance against hydrolysis and a low oxidation resistance caused by the polyunsaturated fatty acids. Therefore vegetable oils should only be used for process temperatures up to 60 °C (140 °F).

Product group	Code according to DIN 51502	Code according to ISO 6743, part 3
Hydraulic oils without additives	H	HH
Hydraulic oils with oxidation inhibitors and corrosion inhibitors	HL	HL
Hydraulic oils HL with additional wear protection additives	HLP	HM
Hydraulic oils HLP/HM with additional viscosity index improvers	HVLP	HV

Classification of the hydraulic oils based on mineral oils  
Source: ABC der Schmierung, Castrol

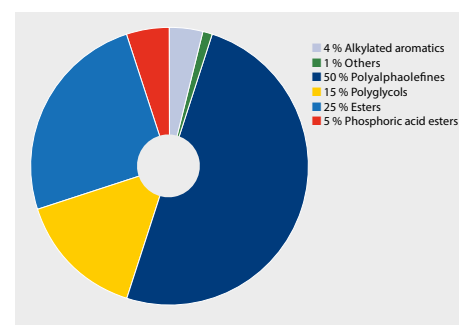

Usage of synthetic base oils in lubricants  
Source: Industrie Report – Synthetische Schmierstoffe, Mobil Schmierstoff GmbH, 1999



## Synthetic oils

There are different types of base oils produced by chemical synthesis. The most important group are the synthetic hydrocarbons with the polyalpha-olefines (PAO) and the alkylated aromatics. They are mainly used for the lubrication of refrigerating machines. Polyalphaolefines are saturated aliphatic hydrocarbons. They have a high oxidation resistance which is comparable with that of mineral oils and they have a very good chemical stability.

The polyglycols are an additional group of synthetic oils with their most important representatives polyethylene glycols and polypropylene glycols. They have a high viscosity index, limited oxidation resistance and very good lubrication properties.

Carboxylic acid esters were originally developed for aircraft engines. Polyol esters and diesters belong to this group. Polyol esters are mainly used for the lubrication of refrigerating machines. Both the polyol esters and the diesters have very good thermal and oxidation resistance and a high viscosity index, usually between 160 and 180. But both groups are susceptible to hydrolysis if they get in contact with water.

The phosphoric acid esters or phosphate esters are tertiary esters of phosphoric acid. They have a low viscosity index, a good oxidation resistance but only in neutral environment, a limited thermal stability and they are susceptible to hydrolysis if they get in contact with water. Fluorinated elastomers should be preferred as secondary sealing elements.

If the oils should be fast and completely biodegradable, then either polyethylene glycols or carboxylic acid esters (diester or polyol esters) should be considered. Good experiences exist for example with Syntolube A5LM from Molyduval and with OMV Sealfluid SH2.

Perfluorinated polyethers are a further group of synthetic oils. They are special lubricants which are very stable and as a consequence they are essentially inert against chemical and corrosive attacks. Beyond this they are non-flammable, non-combustible and harmless for health and environment.

Typical applications are in processes with strong oxidants like oxygen (O<sub>2</sub>), ozone (O<sub>3</sub>), nitrogen oxides (NO<sub>x</sub>), sulfur oxides (SO<sub>x</sub>), halogens (e.g. F<sub>2</sub>, Cl<sub>2</sub>), hydrogen halides (e.g. HF, HCl, HBr) and uranium hexafluoride (UF<sub>6</sub>).

Properties	Mineral oils	Synthetic oils					
		Synthetic hydrocarbons		Polyglycols	Carboxylic acid esters		Phosphoric acid ester
		PAO	Alkylated aromatics		Diesters	Polyol esters	
Rheological behaviour at low temp.	0	++++	++	+++	++++	++++	0
Viscosity at high temp.	+	+++	+	++++	++++	++++	0
Oxidation resistance (with additives)	+	++++	++	+++	++	++++	+
Resistance to hydrolysis	++++	++++	++++	+++	+	+	0
Biodegradability	0	0	0	-	++	+++	0
Toxicity	low	low	low	low	low	low	increased

++++ excellent, +++ very good, ++ good, + acceptable, 0 moderate, - poor

Comparison between the properties of mineral and synthetic oils  
Source: Industrie Report – Synthetische Schmierstoffe, Mobil Schmierstoff GmbH, 1999

	PAO	PAO & Esters	Diesters	Polyglycols	
	Klüberfluid NH1 4-005*	Klüber Summit HySyn FG 15	Klüberoil 4 UH1-15 AF	Klüber Summit DSL 32	Klüber Summit PGS 10 A
General information	Without additives	Mineral oil free compressor oil	Lube oil without additives	Synthetic compressor oil; high oxidation resistance and thermal stability; easily biodegradable	Synthetic compressor- oil; low solubility of gas
Approval regarding food / pharmaceutical applications	NSFH1	USDA-H1 and FDA CFR 178	USDA-H1 and FDA CFR 178	-	-
Operating temperature range [°C]	-40 °C ... +150 °C (-40 °F ... +302 °F)	-45 °C ... +135 °C (-49 °F ... +275 °F)	-45 °C ... +110 °C (-49 °F ... +230 °F)	-30 °C ... +140 °C (-22 °F ... +284 °F)	... +140 °C (+284 °F)
Kinematic viscosity at 40 °C / 100 °C (104 °F / 212 °F)	5 / 1.7 mm <sup>2</sup> /s	15 / 3.6 mm <sup>2</sup> /s	18 / 4.0 mm <sup>2</sup> /s	32 / 5.8 mm <sup>2</sup> /s	8 / 2.5 mm <sup>2</sup> /s
Compatibility with elastomers	Neutral towards numerous HNBR and FKM elastomers			Neutral towards numerous FKM elastomers	Neutral towards numerous HNBR and FKM elastomers

Synthetic oils which are suitable as barrier/buffer medium  
(Recommendations by Klüber Lubrication)  
\*Tested on a test rig of EagleBugmann

Perfluorinated polyethers (PFPE)		
	Klüberalfa YM 3-30	Klüberalfa DH 3-100
General information	Fully synthetic, non-flammable lubricants with good low temperature behaviour	High temperature oil
Operating temperature range	-60 °C ... +100 °C (-76 °F ... +212 °F) (at ≤21 Vol-% oxygen content)	-25 °C ... +180 °C (-13 °F ... +356 °F)
	-60 up to +60 (at ≤21 Vol-% oxygen content)	
Kinematic viscosity at 40 °C / 100 °C (104 °F / 212 °F)	25 / 5 mm <sup>2</sup> /s	100 / 12 mm <sup>2</sup> /s

Perfluorinated polyethers which are suitable as barrier/buffer medium  
(Recommendations by Klüber Lubrication)

## Gaseous barrier/buffer media

are used to operate gas lubricated mechanical seals or as quench medium in combination with liquid lubricated single seals. The most common gaseous barrier/buffer media is nitrogen (N<sub>2</sub>). This can be used for many reaction systems as inert gas. Nitrogen is easily available in most of the production plants via an internal network. Most gas lubricated mechanical seals use nitrogen as the barrier medium. Nitrogen can also be used as gas quench e.g. as icing protection at operating temperatures significantly below 0 °C (+32 °F). The icing of the atmospheric parts of the mechanical seal is avoided by gas injection in the seal cover.

Another typical application is the usage of N<sub>2</sub> as gas quench in combination with liquid lubricated single seals to avoid a reaction of the product leakage with air. Thus contact with oxygen in the air is avoided and no oxidation reaction may occur.

If dry air is used it has to be considered that no reaction takes place between the process medium and air and that no explosive mixtures may form.

When using gaseous barrier/buffer medium it has to be considered that the lower the dew point the dryer the gas and the worse the lubrication capacity becomes. In case of dew point is < -70 °C (158 °F) the wear of the carbon seal faces will be increased. Another common gaseous barrier/buffer medium is steam. It is mainly used as steam quench to heat the atmospheric side of the mechanical seal in case of process media with a high melting point. Thus solidification of the leakage is avoided. A steam quench may also be used to avoid the contact of leakage with the atmosphere if an undesired reaction occurs between the medium and the air. Steam is also used in food applications.

If a steam quench is used, it has to be considered that the steam temperature is high enough to avoid condensation of the steam within the mechanical seal. If condensation could not be avoided the condensate has to be systematically discharged to avoid disadvantages at the mechanical seal.

### Purity requirements on gaseous barrier/buffer media like air and nitrogen according to ISO 8573-1

	Class	Units
Quantity and size of particles	≤ 2	100.000 particles 0.1 ≤ d ≤ 0.5 µm
Humidity class	3	-50 °C (-58 °F) < dew point ≤ -20 °C (-4 °F)
Oil content	≤ 1	≤ 0.01 mg/m <sup>3</sup>



EagleBurgmann GSS4016 gas supply system for gas lubricated mechanical seals.

The main functions of the GSS are:

- Filtering of the barrier or the flushing gas
- Pressure monitoring and control
- Flow monitoring
- Leakage control and discharge

# Not recommended barrier/buffer media

In this chapter some examples for non recommended barrier/buffer media are described. Nevertheless they are often used. These are:

## Antifreeze agents for cars (cooler protection)

Indeed these media are often based on ethylene glycol but contain corrosion inhibitors or other additives like e.g. silicates which may lead to a high wear of the seal faces. Common trade names are e.g. Glysantin.

## Lubricants for automatic transmissions

The so called ATF's (Automatic transmission fluid) and commonly used in the USA because of their good availability and low viscosity. But some additives may cause wear problems at the seal faces. For this reason they should not be used for applications with high operating demands (high pressures, high temperatures, high rotating speeds etc.).

## Silicon oils

have a very good thermal stability, are essentially chemically inert and have a high viscosity index but at high operating demands in most of the cases not very stable. They may contain silicate additives or form silicates at high shear stresses. These glassy particles lead to an increased abrasion or form deposits and will block the movability of the dynamic O-ring. For this reason they should not be used for applications with high operating demands.

## Methanol

is commonly used in low temperature applications with temperatures lower than -40 °C (-40 °F). It has a melting point of -98 °C (-144 °F) and a boiling point of 64.5 °C (148.1 °F). Disadvantages of methanol are the bad lubrication properties and the classification according to the EC-regulation of hazardous substances as toxic.

## Diesel

Low flammable fuel mixtures for diesel engines which mainly consist of paraffines with different contents of olefines, cycloalkanes and aromatic hydrocarbons. Their composition may differ and is mainly dependent on the production process. Normally they have a boiling point between +170 °C ... +360 °C (+338 °F ... +680 °F) and a flash point between +70 °C ... +100 °C (+158 °F ... +212 °F).

Diesel should not be used as barrier/buffer medium because it is subject to the classification according to the EC-regulation of hazardous substances (H351: Suspected of causing cancer).

## Highly purified water

(pharmaceutical water, ultrapure water, HPW – Highly Purified Water, WFI – Water For Injection).

Highly purified water in different qualities is mainly used as barrier/buffer medium in food and pharmaceutical applications and if aseptic operating conditions are required. The quality of "Highly Purified Water (HPW)" and "Water For Injection (WFI)" is the same, whereas WFI may only be produced by distillation processes and HPW may also be produced by using membrane processes.

The problem with highly purified water with conductivities of < 5 µS/cm is the bad lubrication capacity and the high corrosiveness. Suitable materials are required when highly purified water is used. Stainless steels with low ferrite content are resistant whereas 1.4404 and 1.4435 have proved for higher requirements. Beyond this the surface quality has to be on a high level.

SiC against SiC are used as standard seal face materials, whereas specific qualities have proven outstanding suitability. Because of the bad lubrication properties HS-grooves should be used. PTFE or EPDM may be used as elastomer materials.

	PW (Purified Water)	HPW (Highly Purified Water)	WFI (Water For Injection)
Process	Distillation, ion exchange, or other suitable processes	E.g. reverse osmosis combined with ultrafiltration and ion exchange	Distillation
Conductivity	< 4.3 µS/cm at 20 °C (68 °F)	< 1.1 µS/cm at 20 °C (68 °F)	< 1.1 µS/cm at 20 °C (68 °F)

Water qualities according to Pharm. Eur.



# Barrier/buffer media for critical process media

Critical process media and the usage of barrier/buffer media are for example highly concentrated acids and bases. If in this case water is used as the buffer medium (the sealed process pressure is lower than the pressure of the buffer medium) the supply system is enriched very fast with the acid or base process medium which may lead to an increased corrosion. Therefore the flow-through operation mode or a flush with an external medium should be used in this case.

If pressurized operation (pressure of the barrier medium is higher than the sealed process pressure) in combination with water as barrier medium is used, it may produce a spontaneous and large heat development. Beyond this a chemical potential equalization occurs despite the higher barrier pressure and therefore an equalization of the pH-value between the process and the barrier medium takes place quite fast.

A concrete example is the sealing of concentrated sulfuric acid. For this application positive experiences are available with isododecane as barrier/buffer medium at operating temperatures up to 50 °C (122 °F) and the barrier/buffer medium Galden® (perfluorinated polyether). Generally speaking perfluorinated polyethers seem to be suitable for the application with concentrated sulfuric acid because of their high chemical inertness. Paraffin and silicon oils have been found unsuitable several times because they were decomposed by the sulfuric acid.

The trend leads to concentrated sulfuric acid being either hermetically sealed by using a magnetic coupling or sealed by using gas lubricated mechanical seals.

## Service notes

The barrier/buffer medium should be changed regularly. It is recommended to change the barrier/buffer medium after each repair, each shut down or if the concentration of the process medium in the barrier/buffer system is too high, but at least every 12 months. The most economic change interval has to be determined by the operator of the production plant himself dependent on his experience.

In case of acid or alkaline process media the pH-value in the barrier/buffer system may be taken as indicator when to change the barrier/buffer medium. When the pH-value differs more than 2 units from the original value then the barrier/buffer medium should be changed. Beyond this a chloride concentration of 250 ppm should not be exceeded in a closed loop thermosiphon system because an increasing corrosion rate can be the consequence.

## Installation and start-up notes

If the machine is installed outside then the risk of freezing has to be considered. The barrier/buffer medium must not be frozen and also the change in viscosity has to be taken into account (viscosity increases with decreasing temperature). During start-up it has to be ensured that the viscosity is sufficiently low. If necessary the area of the seal can be warmed-up by using a low driving speed of the machine during start-up. In critical cases heating for the area of the seal and if necessary the feed and return pipe should be provided. An insulation of the piping shall be considered as well.



EagleBurgmann barrier system SPA 2000. Pressurized barrier fluid system type SPA in its basic version provide all four functions of a supply system which are necessary for the operation of double mechanical seals: barrier fluid circulation, cooling, pressure build-up in the sealing chamber and leakage compensation.

# A straightforward approach to a suited barrier/buffer medium

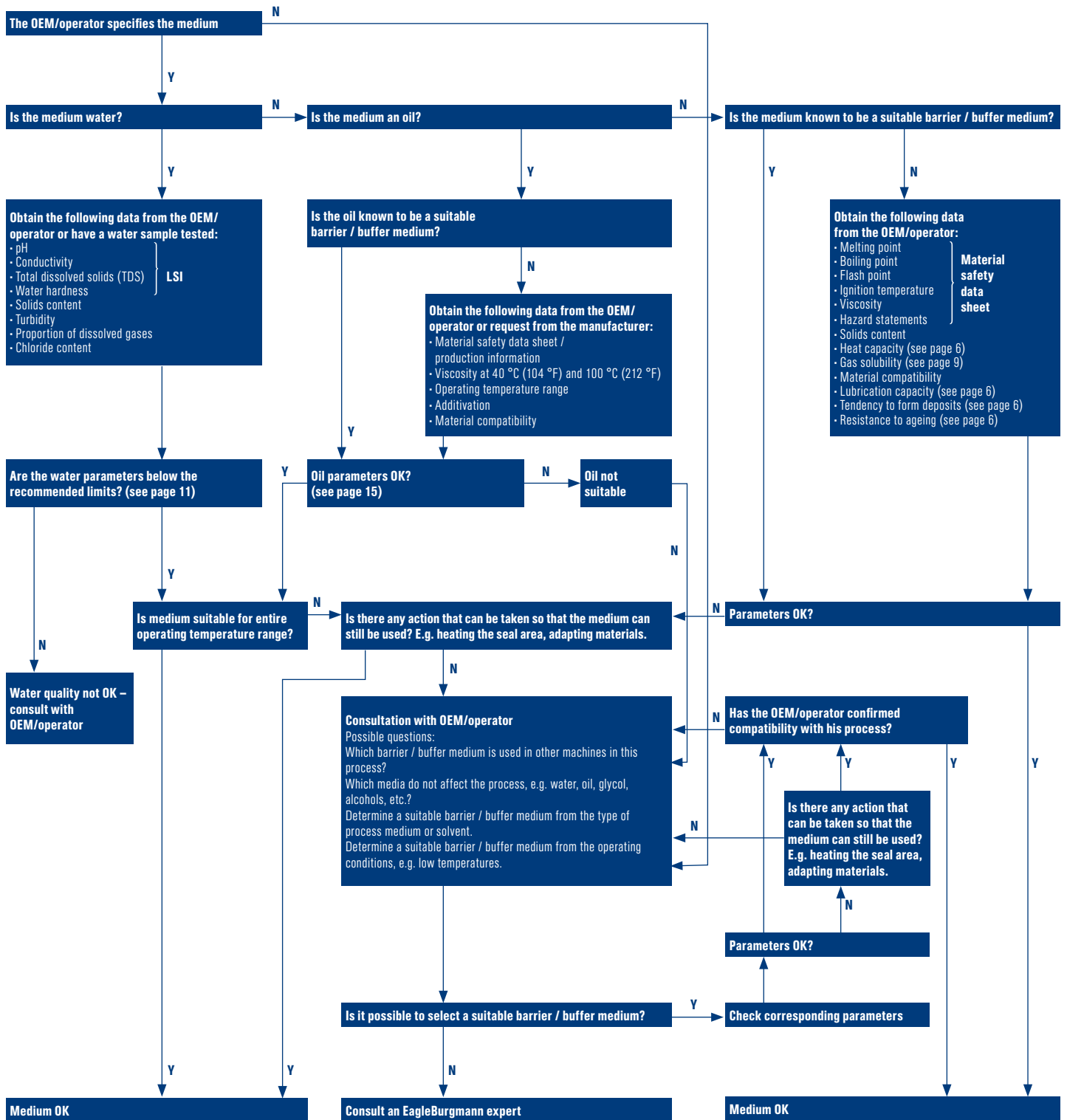

Argentina · Australia · Austria · Belarus · Belgium · Bulgaria · Brazil · Canada · Chile · China · Colombia · Cyprus · Czech Republic · Denmark · Ecuador · Egypt · Estonia  
Finland · France · Germany · Great Britain · Greece · Hungary · India · Indonesia · Iraq · Israel · Italy · Japan · Jordan · Kazakhstan · Korea · Kuwait · Latvia · Libya · Lithuania  
Malaysia · Mauritius · Mexico · Morocco · Myanmar · Netherlands · New Zealand · Nigeria · Norway · Oman · Pakistan · Paraguay · Peru · Philippines · Poland · Qatar  
Romania · Russia · Saudi Arabia · Singapore · Slovenia · Slovak Republic · South Africa · Spain · Sweden · Switzerland · Syria · Taiwan · Thailand · Trinidad and Tobago · Tunisia  
Turkey · Turkmenistan · Ukraine · United Arab Emirates · Uruguay · USA · Uzbekistan · Venezuela · Vietnam · [www.eagleburgmann.com/world](http://www.eagleburgmann.com/world)



63E / EZ / 3.000 / 03.13 / 19.71 © EagleBurgmann Group Marketing, Germany

EagleBurgmann is one of the internationally leading companies for industrial sealing technology. Our products are used everywhere where safety and reliability are important: in the oil and gas industry, refining technology, the petrochemical, chemical and pharmaceutical industries, food processing, power, water, mining, pulp & paper, aerospace and many other spheres. Every day, more than 6,000 employees contribute their ideas, solutions and commitment towards ensuring that customers all over the world can rely on our seals. Our modular TotalSealCare service underlines our strong customer orientation and offers tailor-made services for every application.

**EagleBurgmann Germany GmbH & Co. KG**

Aeussere Sauerlacher Strasse 6–10

82515 Wolfratshausen, Germany

Tel.: +49 (0)8171 23 0

Fax: +49 (0)8171 23 12 14

[info@de.eagleburgmann.com](mailto:info@de.eagleburgmann.com)

[eagleburgmann.com](http://eagleburgmann.com)

**EagleBurgmann®**

Rely on excellence