

Compression packings



Expertise and commitment. Our approach to innovative products and best-in-class service.

Focusing on the customer

EagleBurgmann offers an extensive selection of compression packings, graphite sealing sets and gaskets, providing the right solution for your particular application. We know from experience that it is only when you get down to the details that you fully understand the exact product requirements profile.

Regardless of whether economic, design or safety aspects are your priority, our goal is to give you the best possible leading-edge product. If you are looking for a specially engineered solution, we are always pleased to work with your engineers to create and supply the right seal. That is what we mean by customer focus.

Technological expertise that you can rely on

Our seals are key components for our customers. They make a vital contribution to operational reliability, the environment, and business performance. You get sophisticated, top-class sealing products which you can rely on in day-to-day applications.

EagleBurgmann is known for the reliability, safety and resilience of its products. This gives you peace of mind and lets you concentrate on your core business. We ensure that you get the quality and precision that you expect. Our technological expertise and quality standards are an obligation as well as an incentive for us to provide our customers with the best products. There is good reason why EagleBurgmann repeatedly gets top marks in comparative tests. That is always something you can count on.

EagleBurgmann compression packings selector

The table lists all the key operating data for EagleBurgmann compression packings – classified according to their various potential applications

Packings for Pumps

Packings for Valves

Glass Packings

Media Group		Pump Packings														Valve Packings										Glass Packings											
		Buraflex HT 2000/HT	Buratex 4001..2..3	Burafion 5846	Kombipack 6065	Burasoft 6225/L	Thermofion 6230	Thermofion SL 6230/SL	Isartherm 6060	Buramex SF 6335	Arafion 6426	Spezial-Kombi K2 6430/K2	Suprafion 6435	Burajet 8032/SCA	Burajet 8032/SCB	Burajet 8032/SCH	Burajet 8032/SCW	Spezial-Kombi K1 6430/K1	Rotatherm 0901	Rotatherm 0911	Rotatherm S881/B	Isartherm A 6011/A	Isartherm-Flex 6050	Isartherm-Flex KIN 6050/KIN	Isartherm K-Flex 6051	Chemstar L 6226/L	Chemstar NQ 6226/NQ	Thermofion TR 6232	BuraTAL HT 9650/HT	BuraTAL T3 9650/T3/T4/T5	BuraGlas INC 7260/INC	BuraGlas 9472 & 9480	BuraGlas HT-SJ 9486				
Universal range		■	■	■	■	■	■	■	■	■	■	■	■	■	■	■	■	■	■	■	■	■	■	■	■	■	■	■	■	■	■	■	■	■	■		
Engineered range		■	■	■	■	■	■	■	■	■	■	■	■	■	■	■	■	■	■	■	■	■	■	■	■	■	■	■	■	■	■	■	■	■	■		
FDA certified		■	■	■	■	■	■	■	■	■	■	■	■	■	■	■	■	■	■	■	■	■	■	■	■	■	■	■	■	■	■	■	■	■	■		
Pumps	bar p	40	10	25	25	10	25	25	30	25	25	25	20	15	25	25	25	25	25	25	25	25	15	25													
	m/s vg	40	10	12	20	10	20	20	25	25	25	20	20	10 ⁴⁾	10 ⁴⁾	10 ⁴⁾						15	25														
Valves	bar p	80	60	100		100	100	100	100	100			100	70	75	100	75		800	500	1,000	300	350 ²⁾	500	450	500	500	500	300	250							
	m/s vg	5	2	2		2	2	2		2			2	2	2	2	2		2	2	2	2	2	2	2	2	2	2	2	2	2	2	2	2	2		
Plunger pumps	bar p					100		250	250	100	50	100						500								250	800										
	m/s vg					1.5				2	1.5						3									1.5	2										
Fans, blowers (dry running)	bar p	10																10				8	8														
	m/s vg	10																10				5	2														
Mixers, agitators, kneaders, filters (dry-running)	bar p	40	8	20	25		25		25	25			25	25	25	50					50	50		25	25												
	m/s vg	10	2	2	2		2		2	2			2	2	2	2					5	2		2	2												
Chemical resistance	pH	0..14	6..8	5..11	0..14	0..14	0..14	1..14	1..13	2..12	1..13	1..13	2..12	2..12	0..14	0..14	1..13	0..14	0..14	0..14	2..12	0..14	0..14	0..14	0..14	0..14	0..14	0..14	0..14	1..13	5..9	5..9	5..9				
Temperature resistance	t min °C	-100	-20	-50	-100	-200	-200	-50	-50	-100	-100	-100	-10	-100	-30	-100	-100	-200	-200	-200	-40	-200	-200	-200	-200	-200	-200	-200	-200	-50	-50	-50					
	t max °C	+250	+100	+140	+280	+280	+280	+300	+250	+250	+250	+250	+260	+250	+450	+250	+250	+500	+500	+500	+450	+500	+500	+450	+500	+450	+280 ³⁾	+280	+400	+250	+750 ³⁾	+650	+1,100				
Temperature limit for steam service °C		+180	+140	+280				+180	+180	+180	+180						+180	+550 ⁴⁾	+550 ⁴⁾	+550 ⁴⁾	+550 ⁴⁾	+700	+550	+550													
1; 1	Water, industrial water, sewage	□	■	■	■	□	■	■	□	□	□	□	■	■	■	■	■	■	□	□	□	□	□	□	□	□	□	□	□	□	□	□	□	□	□	□	
1; 2	Sea water	□	■	■	■	□	□	□	□	□	□	□	□	□	□	□	□	■	□	□	□	□	□	□	□	□	□	□	□	□	□	□	□	□	□	□	
2	Drinking water, foodstuffs, pharm. products			■		□	■	■	■	■	■	■	■	■	□	□	□	□	□	□	□	□	□	□	□	□	□	□	□	□	□	□	□	□	□	□	
3	Hot water, boiler feed water, condensate	■		■				□	□	□	□	□	□	□	□	□	□	□	□	□	□	□	□	□	□	□	□	□	□	□	□	□	□	□	□	□	
4; 1	Steam <280 °C	■				□	□	□	□																												
4; 2	<450 °C																																				
4; 3	¹⁾ <550 °C ²⁾ <700 °C																																				
5	Neutral vapours, gases, air, nitrogen	□			■	■	□	□	■	□	□	□	□	□	□	□	□					□	■	■	■	■	□	□	□	□	□	□	□	■	■	■	
6	Acid gases	□			□	■	□	□	■	□	□	□	□	□	□	□	□					□	□	□	□	□	□	□	□	□	□	□	□	□	□	□	
7; 1	Hydrogen	□				□	□	□	□	□	□	□	□	□	□	□	□	□	□	□	□	□	□	□	□	□	□	□	□	□	□	□	□	□	□	□	□
7; 2	Oxygen																																				
8	Volatile hydrocarbons, solvent vapours	□			■	■	□	□	■	□	□	□	□	□	□	□	□					□	■	■	■	■	□	□	□	□	□	□	□	□	□	□	
9	Diluted acids, inorganic/organic salt solutions	□			■	■	■	■	■	□	□	□	□	□	□	□	□	□	□	□	□	□	□	□	□	□	□	□	□	□	□	□	□	□	□	□	□
10	Concentrated acids, inorganic/organic				■	■	■	■	□																												
11	Diluted alkalis, salt solutions	□	□	□	■	□	■	□	□	□	□	□	□	□	□	□	□	□	□	□	□	□	□	□	□	□	□	□	□	□	□	□	□	□	□	□	□
12	Concentrated alkalis				□	□	□	■	□	□	□	□	□	□	□	□	□					□	□	□	□	□	□	□	□	□	□	□	□	□	□	□	□
13	Oils, greases, mineral oils, animal fats	□	□	□	■	□	■	■	□	□	□	□	□	□	□	□	□					□	□	□	□	□	□	□	□	□	□	□	□	□	□	□	□
14	Heat transfer oils	□			□	■	■	□	□	□	□	□	□	□	□	□	□					□	□	□	□	□	□	□	□	□	□	□	□	□	□	□	□
15	Solvents, aliphatic and aromatic hydrocarbons, aldehydes, alcohols, ester ketones, chlorinated hydrocarbons, coolants	□			■	■	□	□	■	□			□	□	□	□	□					□	□	□	□	□	□	□	□	□	□	□	□	□	□	□	□
16	Organic compounds, amines, nitriles	□			□	■	□	□	■	□	□	□	□	□	□	□	□					□	□	□	□	□	□	□	□	□	□	□	□	□	□	□	□
17; 1	Adhesive media, bitumens, glues				□	□	□	■	■	■	■	■	■	■	□	□	■																				
17; 2	Abrasive media, lime, sand, solids			□					■	■	■	■	■	■	■	■	■																				
18	Paints, lacquers, turbine oils				□	□						■	■	■	□	□	□					□	□	□	□	□	□	□	□	□	□	□	□	□	□	□	□

¹⁾ 3,000 °C in inert atmosphere
²⁾ With special chamber rings or in inert atmosphere
³⁾ Short term up to 300 °C
⁴⁾ 4 m/s with lip seals
⁵⁾ +800 °C with mica impregnation
⁶⁾ +1,000 °C for dry gases

□ Resistant ■ Recommended



Important note

All the technical specifications are based on extensive tests and our many years of experience. However, the diversity of possible applications means that they can serve as guide values only.

It should be noted that the extremal values of each operating parameter cannot be applied at the same time because of their interaction. Furthermore, the operating range of each specific product depends on the respective shaft diameter, materials used, mode of operation and on the medium to be sealed.

A guarantee can only be given in the individual case if the exact conditions of application are known and these are confirmed in a special agreement. When critical conditions of operation are involved, we recommend consulting with our specialist engineers. Subject to change.

Media	Media group	Media	Media group	Media	Media group	Media	Media group
A		Cresol	16	K		S	
Accumulator acid	10	Crude oil	13	Kerosene (Jet fuel JP 4, JP 5)	15	Salicylic acid	9; 10
Acetaldehyde	15; 16	Cuprous chloride solution	9; 11			Salt, common (Sodium chloride)	9; 11
Acetic acid	9; 10	Curds	2	L		Sea water	1.2
Acetic acid anhydride	10	Cyclohexane	8; 15	Lacquers	18	Sewage water	1.1
Acetic ether (Ethyl acetate)	8; 15	Cyclohexanol	15	Lead acetate (Lead sugar)	11	Silicon tetrachloride	9; 10
Acetone	8; 15	Cyclohexanone	13; 15	Lead sludge	17.2	Silicone fats	13
Acetylene	8; 15			Lemonades	2	Silicone oils	13
Acrylonitrile	16	D		Lignite tar oil	13; 17.1	Silver salts	9
Adipinic acid	9; 10	Dibutyl phthalate (DBP)	16	Liqueurs	2	Skin creams	2; 13
Alcohol (Ethanol)	15	Diesel fuel				Soap solution	11
Aluminium acetate	9; 11	Diethanolamine (DEA)	11; 16	M		Soda lye $\leq 30\%$ all conc.	11; 12
Aluminium chloride	9; 11	Diethyl ether	8; 15	Magnesium bisulphite	9; 11	Sodium arsenate	9; 11
Aluminium sulphate	9; 11	Diethyl glycol	8; 15	Magnesium hydroxide	11; 12	Sodium carbonate	11; 12
Ammonia (gaseous)	11; 12	Dimethyl ether	8; 15	Maleic acid anhydride	10	Sodium chloride (Common salt)	9; 11
Ammonia (liquid)	11; 12	Dioxane	16	Manganese nitrate	9; 11	Sodium hydroxide (Caustic soda)	11; 12
Ammonia hydroxide	11; 12	Diphenyl heat transfer fluid	14	Manure, liquid	11	Sodium hypochlorite	9; 11
Ammonium chloride	9; 11	Diphenyloxide	15; 16	Marmalade	2	Sodium nitrate	9; 11
Ammonium sulphate	9; 11	Distilled water	2	Mash (Hop mash)	2	Sodium phosphate	9; 11
Aniline	16	Dodecylbenzene	15	Masut (Heavy heating oil)	13	Sodium silicate (Water glass)	9; 11
Anthracene oil	13	Dowtherm [®] -A	14	Meat juices and broths	2	Sodium sulphate (Glauber's salt)	9; 11
Antifreeze solution (Glycols)	15	Dye liquor	17.1	Mercaptane	16	Sodium sulphide	9; 11
Arsenic acid	9; 10			Mercury nitrate	9; 11	Sodium sulphite	9; 11
Asphalt	17.1	E		Methane	8	Sodium thiosulphate (Antichlor)	9; 11
ASTM oil No. 1, 2, 3 and 4	13	Edible oil	2; 13	Methanol (Methyl alcohol)	15	Solvent naphtha	15
		Edible vinegar	9	Methyl chloride	8; 15	Starch solutions	17.1
B		Ethane	15	Methyl ethyl ketone (MEK)	8; 15	Steam	4.1; 4.2; 4.3
Barium chloride	9; 11	Ethanol (Ethyl alcohol)	15	Methylated spirit	15	Stearic acid (Fatty acid)	9; 10
Barium hydroxide	11; 12	Ether (Diethyl ether)	8; 15	Methylene chloride	8; 15	Styrene (Phenyl ethylene)	15
Beer	2	Ethyl acetate (Acetic ether)	15	Milk	2	Sulphite liquor	9; 11
Beer mash, cooper	2	Ethyl cellulose	8	Milk of lime (Calcium hydroxide)	11; 12	Sulphuric acid	
Beer mash, pumps	2	Ethylene	8	Mineral oil (Crude oil)	13	70-90 % 150 °C	10
Benzaldehyde	15	Ethylene chloride	6; 15	Mineral oil	13	90-95 % 70 °C	10
Benzene	15	Ethylene glycol	16	Mobiltherm [®] 600	14	Sulphuric acid, fuming (Oleum)	10
Benzene sulphonic acid	10	Ethylene oxide	8	Molasses	2; 17.1	Sulphurous acid	9; 10
Benzoic acid	9; 10			Monochloro benzene	8; 15		
Benzyl alcohol	15	F				T	
Bitumen	17.1	Faeces	1.1	N		Tallow	13
Blast furnace gas	6	Fats and fatty alcohols	13; 15	N-methyl-pyrrolidone (NMP)	15	Tannic acid	9; 10
Bleaching lye	11	Fatty acids	9; 10	Naphtha	15	Tar	17.1
Blood	2	Fatty alcohol sulphonate	11	Naphthenic acid	9; 10	Tartaric acid	9
Boiler feed water	3	Ferric (III) chloride solution	9; 10	Natural gas	5	Tetrachloromethane	8; 15
Bonder lye	9; 10; 11; 12	Ferric phosphate solution	9; 11	Nitric acid		Tetrahydrofuran	15
Bone fat (dissolved in tri or gasoline)	15	Ferricyanide	9; 11	<10 % 85 °C	9; 10	Thick juice (60 % Sugar solution)	2
Borax solution	11	Fish press water	1.1	>10 % 35 °C	10	Thin juice (Sugar solution)	2; 17.1
Boric acid	9	Fish slurry	1.1	Nitrobenzenes	15	Tin salts	9
Brackish water	11	Fish-liver oil	13	Nitrogen	5	Toluene	15
Brake fluid	13	Fixing bath, acidic	9	Nonyl phenol	15	Trichloroethane	15
Brandy	2; 15	Fluorosilicic acid	10			Trichloroethylene	15
Bromine, aqueous	9; 10	Formaldehyde (Formalin)	15; 16	O		Triethanolamine	11; 16
Bunker oil and fuel	13	Formic acid	9; 10	Oils		Trisodium phosphate	9; 11
Butadiene	16; 17.1	Freon [®]	8; 15	a) Animal oils	13	Turbine oils	18
Butane	8; 15	Frigene [®]	8; 15	b) Vegetable oils	13	Turpentine	15
Butanediol	15	Fruit juices	2	c) Lubricating oils	13		
Butanol (Butylic alcohol)	15	Fruit pulp	2	Olive oil	2; 13	U	
Butanone (Methyl ethyl ketone)	15	Fuel oil	15	Oxalic acid	9; 10	Urea	11; 16
Butylene	8; 15	Fully desalinated water	1.1	Oxygen (gaseous, liquid)	7.2		
Butyl acetate	15					V	
Butyl alcohol (Butanol)	15	G		P		Vegetable paste	2
Butyric acid	2; 9; 10	Gallic acid	9; 10	P 3 [®] lye	10; 11; 12	Vinegar (Edible vinegar)	9
		Gas scrubbing water	1.1; 9	Paints	18	Vinyl chloride	8
C		Gelatin	2	Paper pulp			
Calcium acetate	9; 11	Glacial acetic acid	10	a) Fine quality, hygienic	17.2	W	
Calcium bisulphite liquor (Sulphite liquor)	9; 11	Glauber's salt (Sodium sulphate)	9; 11	b) Synthetic, photographic	9; 11; 17.2	Water glass (Sodium silicate)	9; 11
Calcium chloride	9; 11	Glucose	2	c) Packing paper	9; 11; 17.2	water	
Calcium hydroxide (Milk of lime)	11; 12	Glue	17.1	Peanut oil	13	a) Drinking	2
Calcium hypochlorite (Bleaching lye)	9; 11	Glycerol	15	Pentane	8; 15	b) Distilled	3
Calgonit R [®] (Caustic soda phosphate silicate)	11	Glycolic acid ester	8; 15	Perchloric acid	9; 10	c) Not treated	1.1
Calgonit S [®] (Urea nitrate)	11; 12	Glycolmonoacetate	8; 15	Perchloro ethylene (Per)	8; 15	d) Boiler feed (hot water, condensate)	3
Calgonit [®] (Na-hexameta-phosphate)	11			Petrol	15	e) Reactor, radioactive	1.1
Caprolactam	11; 16	H		Petroleum	15	f) Heavy	1.1
Carbolic acid (Phenol)	9; 10	Heat transfer oil	14	Petroleum ether (Gasoline)	8; 15	g) Brackish, sea	1.2
Carbon bisulphide	15	Heating oil	13	Phenol (Carbolic acid)	9; 10	h) Dirty	1.1
Carbon dioxide (gas)	6	Heavy water	1.1	Phenyl ether	8; 15	Whale oil, train oil	13
Carbon dioxide (liquid)	6	Heptane	8; 15	Phenyl hydrazine	8; 15	Wine	2
Carbon monoxide (gas)	6	Hexane	8; 15	Phosphoric acid	9; 10	Wood pulp	11; 17.2
Carbon tetrachloride	15	Honey	2	Phosphor trichloride	9; 10		
Caustic lime (Calcium hydroxide)	12	Hydraulic fluid (Mineral oil base)	13	Phthalic acid (heating)	9; 10	X	
Caustic potash (Potassium hydroxide)	11; 12	Hydraulic fluid (Phosphate ester base)	13	Phthalic acid anhydride	10	Xylene	8; 15
Caustic soda (Sodium hydroxide)	12	Hydrazine	15	Pine oil	13		
Cellulose	17.2	Hydrochloric acid	9; 10	Potassium carbonate	11; 12	Y	
Chloric acid gas (Hydrogen chloride)	6; 10	Hydrocyanic acid	9; 10	Potassium chloride	9; 11	Yeast pulp	2
Chlorine gas	6; 10	Hydrofluoric acid	10	Potassium cyanide	9; 11		
Chlorine water (Chlorine saturated water)	10	Hydrogen	7.1	Potassium hypochlorite	9; 11	Z	
Chloroacetic acid (mono, di)	9	Hydrogen bromide	6; 9; 10	Potassium nitrate	9; 11	Zinc chloride	9; 11
Chloro sulphonic acid	10	Hydrogen chloride (Chloric acid gas)	6; 9; 10	Potassium silicate	9; 11		
Chlorobenzene	15	Hydrogen peroxide	10	Potassium sulphate	9; 11		
Chlorodiphenyl	15	Hydrogen sulphide	6; 9; 10	Propane	8; 15		
Chloroform	15			Propanol (Propyl alcohol)	15		
Chloroparaffins	15; 17.1	I		Propanone	8; 15		
Chromic acid	10	Iso-octane	8; 15	Propyl acetate (Acetic acid ester)	8; 15		
Chromic salts	9; 11	Isobutyl alcohol	8; 15	Pyridine	15; 16		
Cider	2	Isobutyl ketone	8; 15	Pyrrolidone	11; 12		
Citric acid	9; 10	Isopropyl acetate	8; 15				
Citric juices	2; 9	Isopropyl alcohol	8; 15	Q			
Coconut fat	13	Isopropyl ether	8; 15	Quenching oil	13		
Cod-liver oil	2						
Coke oven gas	5			R			
Copper acetate solution	9; 11			Rapeseed oil	13		
Copper sulphate solution	9; 11			Raw juice (Sugar solution)	2		

Contents



EagleBurgmann invented the mechanically braided, self-lubricating packing. These have been manufactured for over 125 years and have proven to be an invaluable form of seal for process industry during all of this time. Alternative seal technologies have been developed during this period of time but the simplicity and quality of the EagleBurgmann product has maintained our name and its products at the forefront of seal suppliers to industry worldwide.

EagleBurgmann is continuing its tradition of innovation with a range of non-woven packing sets which are an indication of the research and development being applied to meet the demands of increasingly difficult environment legislation and control. The BuraTAL range of products has been created to pass the most critical leakage testing standard e.g. TA-Luft, API 622 and ISO 15848. These products are at the center of our on-site upgrade and consultancy service, helping industry to improve its environmental performance and profitability.

In step with changing times our compression packings can now be offered alongside our TotalSealCare service modules of dedicated engineering and site services. These services provide plant operators with essential engineering know-how combined with resources which can be deployed on site during shut-downs and plant upgrades.

This catalog will give you details of the core of our compression packing range. However, we have many more sealing products which can be offered to meet special applications. Please send your requirements to your local EagleBurgmann sales office. We will be glad to assist you in solving your sealing problems.

AK packings	2
Compression packings for pumps	3
Compression packings for valves	7
Low fugitive emission valve solutions	10
Fire safe packing sets	13
Soot blower packing sets	13
Injectable packings	14
Non-ceramic packings	16
Packing cartridge units	18
Live-loading system	19
Packing workshop tools	20
Technical information	21
Additional products and services	25

Program overview with operating data and media resistance guide.

How to find the right packing quickly and easily:

Open out the flap for a complete overview of all the comparative data needed for selecting seals as you look through the brochure. If you still fail to find a satisfactory solution quickly enough or are unsure about borderline cases, please contact your local EagleBurgmann sales office for assistance. We shall be glad to assist you.



AK-profile packings

EagleBurgmann offers most of its high performance pump and control valve packings in the unique AK format. AK braided packing is the ultimate performance packing which achieves maximum sealing with the minimum of wear and friction.

AK packing gives

- Lower stuffing box forces to achieve a good seal
- Lower friction against the shaft – hence lower energy absorption
- Ensures uniform forces throughout the packing to give maximum sealing against stuffing box wall and excellent controlled lubrication leakage along shaft surface.

Standard braid



AK profile



In contrast to conventional braid, the AK profile offers optimum distribution of tension and amazing accuracy of fit when the packing ring is installed on the shaft or shaft sleeve.

Conventional braided packing

Before installation the packing has a square cross-section.

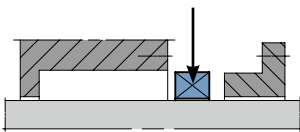

As soon as the packing is wrapped around the shaft it takes on a trapezoidal cross-section because the material is squashed on the inner diameter and stretched on the outside diameter.

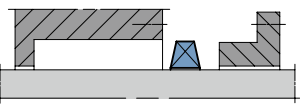

This creates empty spaces on the outside diameter and a lower density along the stuffing box wall when the gland bolts are tightened.

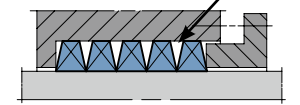

The lower density causes variable sealing forces throughout the packing cross-section and can permit greater leakage along the outer wall of the stuffing box.

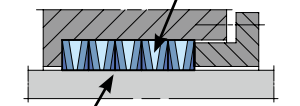

If the pressure along the shaft does not allow controlled leakage, the packing will burn.

Installation of conventional braid

Diagram of forces:

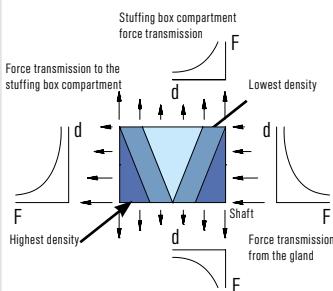

AK-profile braided packing

Before installation the packing has a trapezoidal cross-section.

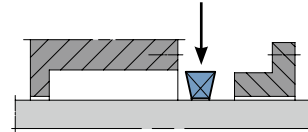

As soon as the packing is laid around the shaft it takes on a square-shaped cross-section because the material is squashed on the inside diameter and stretched on the outside diameter.

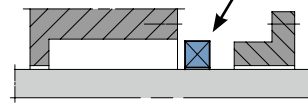

As a result, no empty spaces are created – outside diameter and the density of material is constant across the cross-section.

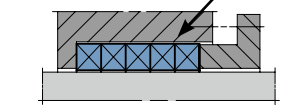

Compression of the packing by the gland follower does not create uneven forces in the packing or at the sliding surfaces.

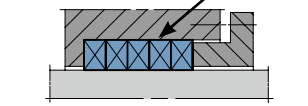

Installation of an AK packing

Diagram of forces:

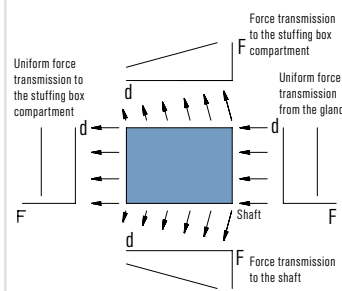

The AK profile – simple and effective

When the AK packing is installed around a shaft, the trapezoidal cross-section of the braiding results in a virtually stress-free seal arrangement.

In the installed state these packing rings are symmetrical, having parallel faces that rule out tilting.

Uniform distribution of the packing material under operating conditions enables selective control of shaft leakage, rules out co-rotation (spinning) of the packing rings and prevents peripheral leakage.

Advantages

- Optimum compression of the packing against the shaft
- Low wear on the shaft, shaft collar and packing
- Costs savings due to the prolonged service life and improved plant availability
- Minimized leakage
- Lower temperature development in the sealing section
- Low power consumption
- Optimum distribution of forces in the packing
- No tilting of the packing rings
- Can generally be made from all grades of yarn
- Straightforward installation

Natural fibers



Buratex B 4001

Cotton packing with black grease impregnation. An ideal economical general purpose pump packing.

Buratex flexible cotton packings are manufactured from selected wear-resistant yarns which are pre-impregnated and twisted. A very intensive secondary impregnation combines with the diagonal braided construction to give a very elastic and soft packing which is resistant to rot.

Range of applications

Ideally in pumps

Installation note

In pump applications, ideally fitted with a straight cut.

Buratex R 4002

Cotton packing with red colored special impregnation. An ideal packing for sea water applications.

Buratex flexible cotton packings are manufactured from selected wear-resistant yarns which are pre-impregnated and twisted. A very intensive secondary impregnation combines with the diagonal braided construction to give a very elastic and soft packing which is resistant to rot.

Range of applications

Pumps, stern tubes, rudder posts

Installation note

In pump applications, ideally fitted with a straight cut.

Buratex W 4003

Cotton packing with light colored grease impregnation. An ideal economical general purpose pump packing for undiluted liquid media and clean applications.

Buratex flexible cotton packings are manufactured from selected wear-resistant yarns which are pre-impregnated and twisted. A very intensive secondary impregnation combines with the diagonal braided construction to give a very elastic and soft packing which is resistant to rot.

Range of applications

Ideally in pumps

Installation note

In pump applications, ideally fitted with a straight cut. The light-colored impregnation avoids any risk of discoloring the medium.

Buraflon 5846

Flexible, easy to handle packing which requires little maintenance and treats shafts gently. Suitable for marine applications and applications in the brewing, drinks, and pharmaceutical industries.

Tough, hard wearing ramie fibers make it wear resistant to abrasive media such as is found in the pulp and paper industry. Furthermore, Buraflon is particularly resistant against degradation of fibers through salt water attack.

Ramie fiber packing, diagonally braided with light coloured special PTFE impregnation to avoid product contamination, using paraffin wax and oil (silicon oil free).

Range of applications

Pumps, plunger pumps, refiners, filters

Available in AK profile.

Parameter	Equipment	Buratex B 4001	Buratex R 4002	Buratex W 4003	Buraflon 5846
Pressure p (bar)	Pumps	10	10	10	25
	Valves	60	60	60	100
	Plunger pumps				100
	Mixers, agitators, kneaders, filters	8	8	8	20
Sliding velocity v_s (m/s)	Pumps	10	10	10	12
	Valves	2	2	2	2
	Plunger pumps				1.5
	Mixers, agitators, kneaders, filters	2	2	2	2
Temperature (°C)		-20 °C ... +100 °C	-20 °C ... +100 °C	-20 °C ... +100 °C	-50 °C ... +140 °C
pH range		6 ... 8	6 ... 8	6 ... 8	5 ... 11
Application		Pumps	Pumps, stern tubes, rudder shafts	Pumps	Pumps, plunger pumps, refiners, filters
Variants					5846/AK
Media resistance		Resistant to water and wastewater	Resistant to water, waste water and sea water	Resistant to water, waste water and partially resistant to oil, greases	Suitable for water, waste water, sea water and drinking water, also for some oils and fats. Not suitable for strong acids or strong alkalis.
Approvals & Certification					FDA US 21 CFR 170,3(i); EPA regulation, article 3, 1935/2004
Supply	Form	Supplied by the meter, pre-cut lengths, die-pressed rings with straight or slanted cut.			
	Stock sizes, mm (other sizes available on request)	8, 10, 12, 14, 16, 18, 20	8, 10, 12, 14, 16, 20	5, 6, 8, 10, 12, 12.7, 14, 16, 18, 20, 22, 25	4, 5, 6, 6.35, 8, 9.5, 10, 12, 12.7, 14, 15, 16, 18, 19, 20, 22, 25
	Contents of boxes	Up to 6 mm: 1 kg Up to 10 mm: 2 kg Up to 13 mm: 3 kg Up to 24 mm: 5 kg From 25 mm: 10 kg			

Aramid fibers



Buramex SF 6335

Universal wear-resistant packing which is very useful to standardise whole sectors of industry – even with abrasive media. Buramex SF has a high cross-sectional density and structural stability. It has good sliding properties to reduce wear and friction.

Buramex SF is made from diagonally braided Nomex white aramid-based yarn with a silicon-free lubricant.

Range of applications

(Centrifugal) pumps, agitators, mixers, kneaders, refiners, conchers

Available in AK profile.

Araflon 6426

High quality, high strength packing for all industry sectors, especially chemical and petro-chemical industry, waste water, and pulp and paper. Araflon is highly resistant to abrasive media and product contamination. It is extremely stable and hard wearing.

Araflon braided packing is made from high quality smooth aramid filament yarn (Kevlar®) with multiple PTFE impregnation and lubricant.

Range of applications

(Centrifugal) pumps, mixers, pulpers

Installation note

Due to the high stability and strength of aramid fibers, we recommend the use of hardened shaft sleeves (with a surface hardness of 40-60 HRC) to avoid wear of sliding surfaces of the shaft. In hot water applications the packing can be used up to 160 °C uncooled.

Available in AK profile.

Supraflon 6435

Supraflon aramid staple fiber packing has high thermal and chemical resistance and is economical in use. The impregnation combines with excellent cross-sectional strength to give long life and good sliding surface performance.

The packing is gentle to shaft surfaces and is ideally suited for applications in the sugar, pulp and paper, and chemical industries.

Supraflon is diagonally braided packing and has silicon-free lubrication with PTFE impregnation.

Range of applications

Pumps, mixers, pulpers, valves

Installation note

Because of the high stability of the aramide fibers, we recommend a surface hardness of 40 ... 60 HRC to avoid excessive wear on the running surfaces of shafts and sleeves.

Parameter	Equipment	Buramex SF 6335	Araflon 6426	Supraflon 6435
Pressure p (bar)	Pumps	25	25	20
	Valves	100		100
	Plunger pumps	50	100	
Sliding velocity v _s (m/s)	Mixers, agitators, kneaders, filters	25	25	20
	Pumps	25	25	20
	Valves	2		2
	Plunger pumps	2	1.5	1.5
Temperature (°C)		-50 °C ... +250 °C	-100 °C ... +250 °C Steam +180 °C	-100 °C ... +250 °C Steam +180 °C
	pH range	1 ... 13	2 ... 12	1 ... 13
Application		Pumps	Pumps, mixers, pulpers	Pumps, valves, mixers, pulpers
Variants		6335/AK	6426/AK	
Media resistance		Resistant to drinking water, food; adhesive media like bitumen or glues; abrasive media like lime, sand, sugar, salt; paints, lacquers, turbine oils.	Recommended for abrasive media, e.g. lime, sand, solids, as well as adhesive media, bitumen, glues.	Recommended for abrasive media, e.g. lime, sand, solids, as well as adhesive media, bitumen, glues.
Approvals & Certification		FDA US 21 CFR 170,3(i); EPA regulation, article 3, 1935/2004		
Supply	Form	Supplied by the meter, pre-cut lengths, die-pressed rings with straight or slanted cut.		
	Stock sizes, mm (other sizes available on request)	5, 6, 6.35, 8, 9.5, 10, 12, 12.7, 14, 15, 16, 18, 19, 20, 25	8, 10, 12, 14, 16, 20	6, 8, 10, 12, 14, 16
	Contents of boxes	Up to 6 mm: 1 kg Up to 10 mm: 2 kg Up to 13 mm: 3 kg Up to 24 mm: 5 kg From 25 mm: 10 kg		

PTFE-based fibers

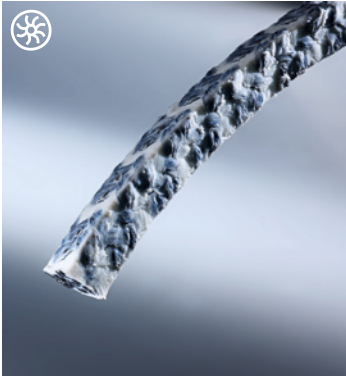

Kombipack 6065

The outstanding design of Kombipack provides low friction forces and very high elasticity. This allows the packing to accommodate shaft misalignment and higher radial forces.

Kombipack has good thermal conductivity, excellent service life due to low cold flow characteristics and high temperature resistance. These features are a benefit of the diagonally braided construction using high quality carbon and PTFE yarns, special PTFE compound and running-in lubricant.

Range of applications

Pumps, stirrers, mixers

Burasoft 6225/L

Flexible packing with excellent emergency running properties. For universal applications in chemical, pharmaceutical, and food industries. Burasoft is a diagonally braided PTFE packing with high structural strength and a silicon-free lubricant.

Range of applications

Pumps, valves

Thermoflon 6230

Diagonal braiding with high cross-sectional density of 100 % original GFO® (graphite-incorporated PTFE yarn).

Thermoflon provides outstanding operating reliability, flexibility, low friction and easy start-up conditions. It has superior thermal conductivity, chemical resistance and a long service life.

Installation note

For hot water applications: The required lubrication must always be a liquid. A cooling system is necessary if insufficient cooling is achieved through media or equipment casing.

Range of applications

Pumps, agitators, mixers, kneaders

Available in AK profile.

Thermoflon SL 6230/SL

Diagonally braided packing made from graphite-incorporated PTFE yarn with additional lubricant.

Thermoflon SL provides outstanding operating reliability, flexibility, low friction and easy start-up conditions. It has superior thermal conductivity, chemical resistance and a long service life.

Installation note

For hot water applications: The required lubrication must always be a liquid. A cooling system is necessary if insufficient cooling is achieved through media or equipment casing.

Range of applications

Pumps, agitators, mixers, kneaders

Available in AK profile.

Parameter	Equipment	Kombipack 6065	Burasoft 6225/L	Thermoflon 6230	Thermoflon SL 6230/SL
Pressure p (bar)	Pumps	25	10	25	25
	Valves		100	100	100
	Plunger pumps			250	250
Sliding velocity v_s (m/s)	Mixers, agitators, kneaders, filters	25		25	25
	Pumps	20	10	20	20
	Valves		2	2	2
	Plunger pumps			2	2
Temperature (°C)		-100 °C ... +280 °C	-200 °C ... +280 °C	-200 °C ... +280 °C Note: Hot water, without cooling ... +140 °C	-200 °C ... +280 °C Note: Hot water, without cooling ... +140 °C
	pH range	0 ... 14	0 ... 14	0 ... 14	0 ... 14
Application		Pumps, agitators, mixers	Pumps, valves	Pumps, agitators, mixers, kneaders	Pumps, agitators, mixers, kneaders
Variants			6225/LAK	6230/AK	6230/SLK
Media resistance		Resistant to alkalis, solvents, alcohols, ester-ketones, oils, acids, hot water, brine, ammoniac.	Universal chemical resistance, not suitable for abrasive media or hot water, hot steam, and oxygen applications.	Universal chemical resistance, except strongly oxidising media like oleum, fuming nitric acid, gaseous fluorine, and molten alkali metals.	Universal chemical resistance for food applications as well as for paints, dyes, and lacquers. Not suitable for hot steam or abrasives.
Approvals & Certification		FDA US 21 CFR 170,3(i); EPA regulation, article 3, 1935/2004	FDA US 21 CFR 170,3(i); EPA regulation, article 3, 1935/2004		FDA US 21 CFR 170,3(i); EPA regulation, article 3, 1935/2004
Supply	Form	Supplied by the meter, pre-cut lengths, die-pressed rings with straight or slanted cut.			
	Stock sizes, mm (other sizes available on request)	8, 10, 12, 14, 16, 18, 20, 25 All sizes are non-stock and will be made to order	6, 8, 10, 12, 14, 16, 20	4, 5, 6, 6.35, 8, 9.5, 10, 12, 12.7, 14, 15, 16, 18, 19, 20, 22, 25	4, 5, 6, 6.35, 8, 9.5, 10, 12, 12.7, 14, 15, 16, 18, 19, 20, 22, 25
	Contents of boxes	Up to 6 mm: 1 kg Up to 10 mm: 2 kg Up to 13 mm: 3 kg Up to 24 mm: 5 kg From 25 mm: 10 kg			

Special fibers



Isartherm 6060

Diagonal braided packing made from high purity carbon fibers. The fibers are combined with a silicon-free lubricant which has especially high speed/load running capabilities.

Pre-impregnated high performance yarns are combined with special lubricants during the braiding process to form a well balanced high quality packing.

The special packing for the pulp and paper industry and for applications in industries with high demands on functionality and durability.

Range of applications

Agitators, Mixers, Blenders, Digesters, Pumps

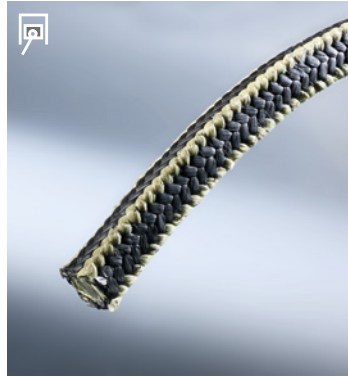

Spezial-Kombi K1 6430/K1

High quality combination of PTFE/graphite yarns diagonally braided with corners of aramid fibre to reduce gap extrusion.

Special packing for high pressure applications with simultaneous sliding motion as in plunger pumps. It has good thermal conductivity and excellent sliding characteristics.

Range of applications

Plunger pumps

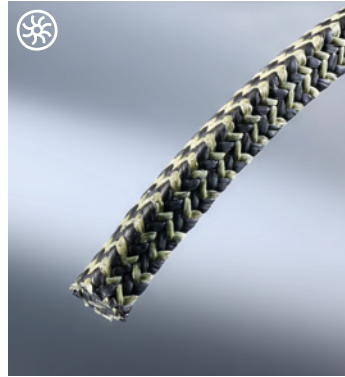

Spezial-Kombi K2 6430/K2

High-grade combination of graphite incorporated PTFE, with reinforcement made of endless aramid fibres (Kevlar®). Diagonally braided. Superior performance with gentle treatment of sliding surfaces.

Range of applications

Centrifugal pumps

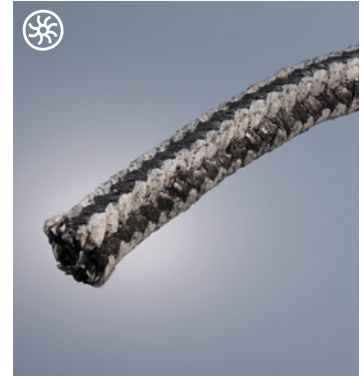

Buraflex HT 2000/HT

THE pump packing for high temperatures and very high sliding speeds due to the quality of its graphite base material and its structural strength.

Buraflex HT is made from diagonally braided permanently elastic, expanded graphite foils, aramid fiber corners, with a high performance lubricant. It has very high thermal conductivity which also makes it particularly suitable for use in control valves.

Range of applications

Centrifugal pumps, control valves, compressors, blowers, fans

Installation note

Buraflex HT is very gentle on shaft surfaces and does not harden. It is not suitable for plunger pumps.

Parameter	Equipment	Isartherm 6060	Spezial-Kombi K1 6430/K1	Spezial-Kombi K2 6430/K2	Buraflex HT 2000/HT
Pressure p (bar)	Pumps	30		25	60
	Valves	100			80
	Plunger pumps	100	500		
Sliding velocity v _s (m/s)	Mixers, agitators, kneaders, filters		50		40
	Pumps	25		20	40
	Valves				5
	Plunger pumps		3		
Temperature (°C)		-50 °C ... +300 °C	-100 °C ... +250 °C Steam: +180 °C	-100 °C ... +250 °C Steam: +180 °C	-100 °C ... +250 °C Steam: +180 °C
	pH range	1 ... 14	1 ... 13	1 ... 13	1 ... 13
Application		Pulpers, refiners, paper mills, centrifugal pumps, plunger pumps, agitators, mixers, kneaders.	Plunger pumps	Pumps	
Variants					
Media resistance		Universal chemical resistance, except strongly oxidising media like oleum, fuming nitric acid, gaseous fluorine, and molten alkali metals.	Suitable for water, waste water, sea water, as well as abrasive and adhesive media. Not suitable for strong acids or strong alkalis.	Suitable for abrasive and adhesive media.	Water, effluents, sea water, hot water, boiler feed water, condensate, water vapour, neutral vapours, gases, air, nitrogen. Especially suitable for hot water and steam up to 280 °C.
Approvals & Certification					
Supply	Form	Supplied by the meter, pre-cut lengths, die-pressed rings with straight or slanted cut.			
	Stock sizes, mm (other sizes available on request)	5, 6, 8, 10, 12, 12.7, 14, 15, 16, 18, 20, 25	10, 12, 12.7, 16	8, 10, 12, 14, 16, 20, 25	6, 8, 9.5, 10, 12, 12.7, 14, 16, 18, 20, 22
	Contents of boxes	Up to 6 mm: 1 kg Up to 10 mm: 2 kg Up to 13 mm: 3 kg Up to 24 mm: 5 kg From 25 mm: 10 kg			

PTFE fibers



Chemstar L 6226/L

Universal PTFE packing preferred for use in the chemical, pharmaceutical, and food industry. Chemstar L demonstrates good strength and resistance to extrusion under pressure.

The packing is diagonally braided from sintered, multifilament, 100 % pure PTFE yarn with full PTFE impregnation throughout the packing structure.

Range of applications

Pumps, mixers, kneaders, filters, agitators

Chemstar NQ 6226/NQ

This low chloride packing is nuclear quality for special service in power plant valves.

Chemstar NQ is diagonally braided from 100 % PTFE silk impregnated with pure PTFE dispersion.

Range of applications

Valves

Installation note

For gaps >0.03 x cross section of the packing between the gland and the shaft or shaft housing we recommend the use of Thermoflon TR (6232) header rings. We offer full quality assurance according to customer specification as required.

We can also provide quality monitoring including certification according to agreed specifications upon request.

Thermoflon TR 6232

Thermoflon TR is suitable as an anti-extrusion ring for preventing gap extrusion. High thermal conductivity and the particular structure of the fiber make it useful in applications with temperature cycling. The packing is resistant to embrittlement and aging. Volumetric and structural stability and excellent cross-sectional density are also features of this very pure, gentle packing.

High-purity, graphite-incorporated PTFE without any added lubricants and fillers.

Range of applications

High-pressure valves, plunger pumps, agitators, mixers, kneaders

Parameter	Equipment	Chemstar L 6226/L	Chemstar NQ 6226/NQ	Thermoflon TR 6232
Pressure p (bar)	Pumps			
	Valves	500	500	800
	Plunger pumps	250		500
	Mixers, agitators, kneaders, filters	25		25
Sliding velocity v_s (m/s)	Pumps			
	Valves	2	2	2
	Plunger pumps	1.5		2
	Mixers, agitators, kneaders, filters	2		2
Temperature (°C)		-200 °C ... +280 °C	-200 °C ... +280 °C, short term +300 °C	-200 °C ... +280 °C
pH range		0 ... 14	0 ... 14	0 ... 14
Application		Valves, mixers, kneaders, agitators	Valves	High pressure valves, plunger pumps, agitators, mixers, kneaders
Variants				
Media resistance		Universal chemical resistance, except strongly oxidising media like oleum, fuming nitric acid, gaseous fluorine, and molten alkali metals.	Universal chemical resistance, not suitable for abrasive media or hot water, hot steam applications.	Universal chemical resistance, also suitable for food applications. Not suitable for hot steam or abrasive media.
Approvals & Certification		BAM approval for oxygen: 150 °C and 40 bar; >150 °C to 200 °C and 30 bar FDA US 21 CFR 170,3(i); EPA regulation, article 3, 1935/2004		BAM-approval for liquid and gaseous oxygen up to 40 °C and 65 bar; or 200 °C and 50 bar. Fraunhofer-Institute: FDA US 21 CFR 170,3 (i); EPA regulation, article 3, 1935/2004
Supply	Form	Supplied by the meter, pre-cut lengths, die-pressed rings with straight or slanted cut.		
	Stock sizes, mm (other sizes available on request)	3, 4, 5, 6, 6.35, 8, 10, 11, 12, 12.7, 14, 15, 16, 18, 19, 20, 22, 25	4, 5, 6, 8, 10, 12 (Other sizes on request)	6, 8, 10, 12, 14, 16
	Contents of boxes	Up to 6 mm: 1 kg Up to 10 mm: 2 kg Up to 13 mm: 3 kg Up to 24 mm: 5 kg From 25 mm: 10 kg		

Graphite fibers

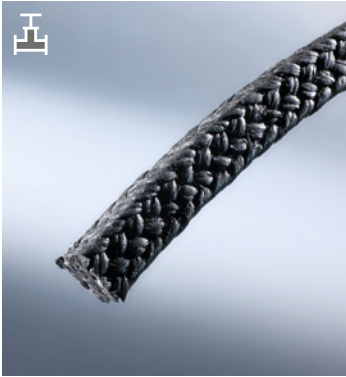

Isartherm A 6011/A

One of the outstanding packings for high pressure and temperature duties, especially for valves and fans in power plant service. Long and extensive field experience has proven the great reliability and safety of this compact and elastic packing.

It can also be used in locations with unknown gap sizes and critical (poor) surfaces (i.e. because of corrosion) or in combination with pressed graphite rings as anti-extrusion header rings with Rotatherm. Isartherm A is diagonally braided and is made from pure graphite fiber with a specially developed heat resistant impregnation.

Range of applications

Valves, fans, mixers, agitators

Installation note

Isartherm cannot be used as a cover plate or Brettschneider seal. For this application, we recommend the Statotherm pure graphite or Statotherm V-Flex cover plate seals, which have proven to be excellent over a long period.

Isartherm-Flex 6050

A flexible and adaptable packing for applications in high pressure and high temperature services.

As a standard packing suitable for almost every industrial sector, especially power plants and the chemical industry. Isartherm-Flex is wear resistant and gentle to the shaft.

Range of applications

Valves, pumps, static applications

Installation note

If there are large gaps in the compression packing sizing, we recommend using the Isartherm Flex KIN part. no. 6050/KIN as the header ring.

Isartherm K-Flex 6051

Elastic, extrusion resistant packing for applications with high temperature and pressure. Particularly appropriate for power plants and chemical applications.

Isartherm K-Flex is diagonally braided from expanded graphite with reinforced carbon fiber corners.

Range of applications

Pumps, valves

Installation note

To be used as a stand-alone packing or in combination with pressed graphite rings (e.g. Rotatherm) as anti-extrusion rings.

Parameter	Equipment	Isartherm A 6011/A	Isartherm-Flex 6050	Isartherm-Flex KIN 6050/KIN	Isartherm K-Flex 6051
Pressure p (bar)	Pumps		15		25
	Valves	300	350 <500 on request	500	450
	Plunger pumps				
Sliding velocity v_s (m/s)	Fans	8		8	
	Mixers, agitators, kneaders, filters	50		50	
	Pumps		15		25
Temperature (°C)	Valves	2	2	2	2
	Plunger pumps				
	Fans	5		2	
pH range		5		2	
Application		5		2	
Variants		-40 °C ... +450 °C Steam: +550 °C	-200 °C ... +500 °C Steam: +700 °C	-200 °C ... +500 °C Steam: +550 °C	-200 °C ... +450 °C Steam: +550 °C
Media resistance		2 ... 12	0 ... 14	0 ... 14	0 ... 14
Approvals & Certification		Valves, fans, mixers, agitators	Pumps, valves	Valves, fans, mixers	Pumps, valves
Supply		Especially suitable for hot water and hot steam. Not suitable for strong acids or strong alkalis.	Wastewater, sea water, hot water, boiler feed water, condensate, steam, neutral steams, air, nitrogen, acidic gases, hydrogen, volatile hydrocarbons, oils, mineral oils, greases, heat transfer oils and volatile solvents.	Water, wastewater, sea water, hot water, boiler feed water, condensate, steam, neutral steams, air, nitrogen, acidic gases, hydrogen, volatile hydrocarbons, oils, mineral oils, greases, heat transfer oils and volatile solvents. Not suitable for strongly oxidising adhesive and abrasive media. Yarmouth Research: API 589 – Fire safe	Resistant to hot water, steam, gases, oils, acids and alkalis. Not resistant to strongly oxidising media in high concentrations.
	Form	Supplied by the meter, pre-cut lengths, die-pressed rings with straight or slanted cut.			
	Stock sizes, mm (other sizes available on request)	3, 4, 5, 6, 6.35, 8, 9, 9.5, 10, 12, 12.7, 14, 16,	4, 5, 6, 6.35, 7, 8, 9, 9.5, 10, 12, 12.7, 14, 15, 16	4, 5.6, 6.35, 7, 8, 9, 9.5, 10, 12, 12.7, 14, 15, 16	5, 6, 8, 9.5 10, 12, 12.7, 14, 16, 18, 19, 20, 22, 25
	Contents of boxes	Up to 6 mm: 1 kg Up to 10 mm: 2 kg Up to 13 mm: 3 kg Up to 24 mm: 5 kg From 25 mm: 10 kg			

Graphite

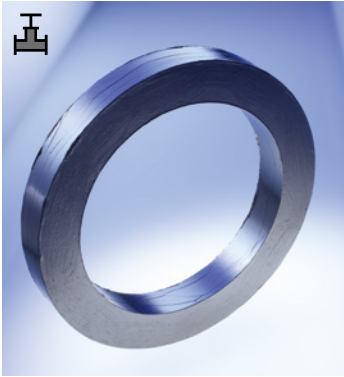

Rotatherm 0901/B ... /0911B

Rotatherm rings are precision seals, with an excellent sealing action and outstanding long service life. They are non-hardening, with very low surface friction.

Rotatherm 0901/B ...

Permanently elastic, pure expanded graphite (99.8 % graphite) without binders or fillers, die-pressed.

Rotatherm 0911/B ...

A standard seal for almost any media in a boiler system. Permanently elastic, expanded graphite (98 % graphite) without binders or fillers.

Installation note

Spindle and stuffing box surfaces have to be clean and in a sound condition (a general requirement for a safe and long service life).

Rotatherm tape 0902

Rotatherm sealant tape for sealing valve spindles during service. Quick and easy, packing rings with good performance can be produced directly within the valve. Non-hardening, long service life, easy installation. The tape is made of pure graphite (99.8 %). Also available in nuclear quality.

Range of applications

Valves

Installation note

Packing size < 6 mm: use 10 mm tape
 Packing size < 9 mm: use 15 mm tape
 Packing size < 12 mm: use 20 mm tape
 Packing size < 15 mm: use 25 mm tape

Rotatherm S881/B

Rotatherm reinforced rings are precision seals which have superior performance in severe applications. Rings can be supplied with metal caps for extrusion resistance particularly where there are high temperatures and pressures combined with large gaps. The rings are made from pure graphite (99.8 %) with internal, expanded stainless steel inserted reinforcement arranged to be non-contacting with metallic components.

Range of applications

Valves

Installation note

The spindle and stuffing box must be clean and in perfect condition (as these are important if the valve is to work well for long periods). Adjust the valve spindle position so that it can be actuated in the packing ring tightening direction once the packing is partly sealed. Design and installation see page 21.

Parameter	Equipment	Rotatherm 0901/B ...	Rotatherm 0911/B ...	Rotatherm tape 0902	Rotatherm S881/B
Pressure p (bar)	Pumps				
	Valves	800	500	500	1,000
	Plunger pumps				
	Fans	10			
Sliding velocity v_s (m/s)	Mixers, agitators, kneaders, filters				
	Pumps				
	Valves	2	2	2	2
	Plunger pumps				
Temperature (°C)	Fans	10			
	Mixers, agitators, kneaders, filters				
Temperature (°C)		-200 °C ... +500 °C Steam: +550 °C Inert atmosphere: +3,000 °C	-200 °C ... +500 °C	-200 °C ... +500 °C Steam: +550 °C	-200 °C ... +500 °C Steam: +550 °C Inert atmosphere: +3,000 °C
pH range		0 ... 14	0 ... 14	0 ... 14	0 ... 14
Application		Valves, fans	Valves	Valves	Valves
Variants		0901/B5: density 1.3 g/cm ³ 0901/B6: density 1.4 g/cm ³ 0901/B7: density 1.6 g/cm ³ 0901/B8: density 1.8 g/cm ³	0911/B5: density 1.3 g/cm ³ 0911/B6: density 1.4 g/cm ³ 0911/B7: density 1.6 g/cm ³ 0911/B8: density 1.8 g/cm ³		
Media resistance		Resistant to almost all organic and inorganic acids, alkalis, oils and solvents.	Resistant to almost all organic and inorganic acids, alkalis, oils and solvents.	Resistant to almost all organic and inorganic acids, alkalis, oils and solvents.	Resistant to almost all organic and inorganic acids, alkalis, oils and solvents.
Approvals & Certification		BAM (O ₂) up to 300 °C and 300 bar			
Supply	Form	Available as full rings (initial installation) and split rings (replacement)		Rolls, boxed	Die-pressed rings clearly marked to denote metal inserts
	Stock sizes, mm (other sizes available on request)	Made to order	Made to order	10, 15, 20, 25	Made to order
	Contents of boxes			Tape 10 < 15 mm wide: 12 m/box Tape 20 < 25 mm wide: 15 m/box	

Low fugitive emission valve solutions



The installation of high quality products to control volatile emissions and the associated monitoring systems along with comprehensive training create the ideal conditions for optimizing your production equipment.

Plant operators now have to work extremely hard to meet the growing environmental protection regulations around the world. The compliance with these regulations can not only have a direct impact on the production process but also on overall plant profitability.

The challenges facing processing industry go far beyond the usual production and business issues. There are increasing demands worldwide to the effect that industry should not only limit but actually reduce the environmental impact of its activities over the long term.

These demands have now been translated into a whole series of environmental protection laws which have a significant effect on industry. In Europe, implementation of the IPPC directive and the introduction of the ISO 15848 standard for valve leakage levels make it imperative that all processing systems comply with extremely stringent emission limits. Similar standards such as API 622 and the TA-Luft directive in Germany have also created the need for low leakage sealing systems for valves and equipment connections.

Plant operators will have to comply with these new regulations and provide evidence on a regular basis that their systems are compliant at all times. Process plants must use the best possible practices and significant penalties can be imposed for non-compliance.

As one of the world's leading sealing companies, EagleBurgmann has a range of products which can meet these new laws without putting pressure on the maintenance budget.

Better performance

State-of-the-art seal technology can limit the potential release of product to the atmosphere. More reliable seal systems might appear to be more expensive, but when the quality is right and proper maintenance is performed, the replacement intervals become significantly lower. EagleBurgmann offers its BuraTAL sealing products for valves and flanges which meet the most stringent volatile emission regulations.



Greater efficiency

Reliable BuraTAL sealing sets reduce stoppages and downtime. They are designed to minimize spindle and shaft friction. This increases service life and reduces power losses in valve actuators.

Lower emissions

All BuraTAL packing sets have been proven to comply with current emission regulations (e.g. TA-Luft, ISO 15848, API 622) and ensure conformance of the process equipment.

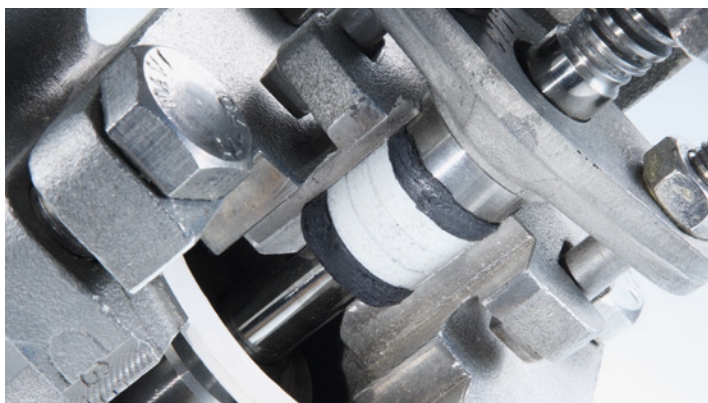

Low fugitive emission valve solutions



BuraTAL HT 9650/HT

BuraTAL HT is a completely new design of packing set developed for upgrading valves to fugitive emission standards. It achieves this sealing adaptability through the following components:

- Braided end rings of expanded pure graphite with reinforced corners of carbon fiber yarn.
- Sealing rings of expanded pure graphite, with very high density to maintain cross-sectional tightness under load.
- Especially impregnated adapter rings of very dense expanded pure graphite
- Inner sealing ring of lower density, of expanded pure graphite, treated with a friction reducing coating.

BuraTAL HT is the universal sealing set for valves. Thanks to its extremely ingenious design and shape this set fulfills the IPPC Directive and TA-Luft standard even at high temperatures. Because of the special material selection combined with the unique geometric design this set achieves very low spindle torques at high temperatures even with temperature cycling.

BuraTAL HT can achieve the TA-Luft leakage requirements without live-loading across a wide range of applications. It is an ideal set for upgrading existing valves to fugitive emission standards because of its ability to seal worn and over-size stuffing boxes and spindles.

Range of applications

Valve sealing kit – for high pressures and temperatures, particularly in TA-Luft applications, for standardization without live-loading. Universal kit for use in all valve applications, such as the processing, chemical, petrochemical and mineral oil (refineries) industries.

Gland compressed

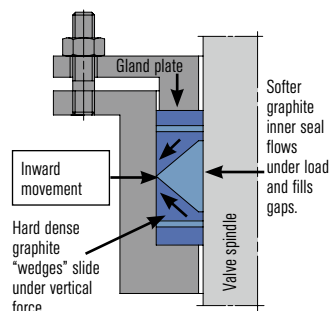

BuraTAL-Flex 6070

The BuraTAL-Flex 6070 is a graphite-based high-efficiency packing whose innovative multi-layer structure guarantees the requirements regarding tightness and flexibility in the most difficult of applications. The multi-layer structure combines the advantages of the greatest possible gap bridging due to the interior Inconel® wire reinforcement and the protection of the high-quality spindle surfaces in the valves at the same time.

The BuraTAL-Flex 6070 is manufactured of highly purified expanded graphite yarns. The purity is >99 %. In combination with a newly developed high-temperature impregnation, the packing complies with the strict leakage threshold values in accordance with ISO 13848 and TA-Luft (Technical Instructions on Air Quality Control). For long-term stable use in the high temperature range, the packing is additionally processed with a corrosion inhibitor. The BuraTAL-Flex 6070 is a high-efficiency packing which can be installed without special end rings.

Apart from compliance with the European emission directives, the BuraTAL-Flex 6070 was not only certified in accordance with the API 622 directive but also in accordance with the stricter requirements of Chevron Texaco (5,000 spindle strokes with 10 temperature cycles). Usage in areas in accordance with Fire-Safe API 589 was demonstrated by a test at the Yarmouth Institute. These properties make the BuraTAL-Flex 6070 the ideal solution for end users and valve service companies.

Parameter	Equipment	BuraTAL HT 9650/HT	BuraTAL-Flex 6070
Pressure p (bar)	Pumps		
	Valves	300 (80 – TA-Luft)	450
	Plunger pumps		
Sliding velocity v _s (m/s)	Mixers, agitators, kneaders, filters		
	Pumps		
	Valves	2	2
Temperature (°C)	Plunger pumps		
	Mixers, agitators, kneaders, filters		
		-200 °C ... +400 °C Steam: +550 °C	-200 °C ... +450 °C, Steam: 650 °C
pH range		0 ... 14	1 ... 14
Application		Valves	Valves
Variants		9650/HTB (with live-loading set)	
Media resistance		Resistant to most chemicals (solvents, hydrocarbons, acids, alkalis), steam, alcohols, oils, water, etc.	Hot water, steam, gases, oils, acids and alkalis. Exceptions: Strongly oxidizing acids as sulphuric acid and nitric acid in higher concentration.
Approvals & Certification		TA-Luft certified by MPA Stuttgart including testing at 400 °C, 40 bar, and 1,000 cycles – No live-loading. API 622, API 589 (Fire safe).	ISO 15848, Fire safe acc. to API 589, Leakage test acc. to API 622, Leakage test acc. to Chevron Texaco Testcert.
Supply	Form	Customised sealing set with or without live-loading system.	Supplied by the meter
	Stock sizes, mm (other sizes available on request)	Made to order	

Low fugitive emission valve solutions

BuraTAL T.. is an unique range of packing sets made from patented non-woven technology to provide a flexible, low friction, hard wearing sealing set for process and control valve applications. This technology combines dimensional stability, cross-sectional impermeability and low friction in a unique way.

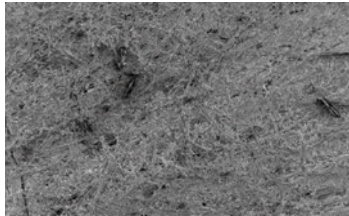

Non-woven fiber matrix

- No leakage paths
- Interlocking, multi-directional fibers prevent cold flow of PTFE impregnation

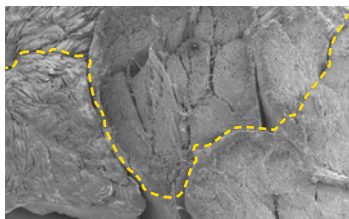

Conventional braided PTFE packings

- Visible leakage paths between the fibers
- PTFE is prone to cold flow and this leads to gap extrusion and insufficient elasticity



BuraTAL T3 9650/T3

Made from 2 end rings of non-woven carbon fiber impregnated with graphite/PTFE. The middle rings are made from aramid non-woven material with PTFE impregnation. This set shows very good performance under temperature cycling over a wide temperature range. Low gap extrusion and reduced cold flow complete its excellent properties.

Range of applications

For universal use in all valves in the chemical and processing industries. Especially suitable where high gas sealing performance with low friction is required, particularly in control valves.



BuraTAL T4 9650/T4

Made from 2 rings on the atmospheric side of non-woven carbon fiber impregnated with graphite/PTFE. The product-side rings are made from aramid non-woven material with PTFE impregnation.

Range of applications

For universal use in all valves in the chemical and processing industries that demand total elimination of impurities from the media. Especially suitable where high gas sealing performance with low friction is required, particularly in control valves.



BuraTAL T5 9650/T5

Made of 4 (or 5) rings of aramid non-woven material with pure PTFE impregnation with high cross-sectional stability. Ideal for control valves requiring extremely low friction and maximum sealing performance.

Range of applications

Particularly suitable for use in control valves where white packings with the lowest friction and absolute minimal leakage rates are required, such as TA-Luft applications. For universal use in all valves in the chemical and processing industries. Especially suitable where high gas sealing performance with low friction is required.

Parameter	Equipment	BuraTAL T3 9650/T3	BuraTAL T4 9650/T4	BuraTAL T5 9650/T5
Pressure p (bar)	Pumps	250 max. 30 – TA-Luft, no live-loading 63 – TA-Luft with live-loading	250 max. 30 – TA-Luft, no live-loading 63 – TA-Luft with live-loading	250 max. 30 – TA-Luft with live-loading
	Valves			
	Plunger pumps			
	Fans			
Sliding velocity v_s (m/s)	Mixers, agitators, kneaders, filters	2	2	2
	Pumps			
	Valves			
	Plunger pumps			
Temperature (°C)	Fans	-50 °C ... +250 °C	-50 °C ... +250 °C	-200 °C ... +280 °C
	Mixers, agitators, kneaders, filters			
pH range		1 ... 13	1 ... 14	1 ... 14
Application		Valves	Valves	Valves
Variants		9650/T3B (with live-loading)	9650/T4B (with live-loading)	9650/T5B (with live-loading)
Media resistance		Resistant to all media except strongly oxidising media like hot sulphuric or nitric acid.	Resistant to almost all organic and inorganic acids, alkalis, oils and solvents.	Universal chemical resistance, except strongly oxidising media like oleum, fuming nitric acid, gaseous fluorine, and molten alkali metals.
Approvals & Certification		TA-Luft cert. by MPA Stuttgart: <250 °C, 30 bar/1,000 cycles <250 °C, 40 bar/2,000 cycles (with live-loading) with live-loading in-house certified: <250 °C, 63 bar/1,000 cycles <250 °C, 40 bar/100,000 cycles	TA-Luft cert. by MPA Stuttgart: <250 °C, 30 bar/1,000 cycles In-house: <250 °C, 40 bar/1,000 cycles	In-house: <250 °C, 40 bar/1,000 cycles
Supply	Form	Customised sealing sets made from endless or split, pre-compressed rings with and without live-loading.	Customised sealing sets made from endless or split, pre-compressed rings with and without live-loading.	Customised sealing sets made from endless or split, pre-compressed rings with and without live-loading.
	Stock sizes, mm (other sizes available on request)	Made to order	Made to order	Made to order

Fire safe packing sets



Soot blower packing sets



Fire safe packing set 9650/FS

The EagleBurgmann fire safe packing set is a high performance set designed for the most arduous service. It is made from a combination of expanded pure graphite and stainless steel components.

R901/B7K (with steel cap), 6050/KIN (packing), 9591 (gasket 2 mm), 6050/KIN (packing), 9591 (gasket 2 mm), 6050/KIN (packing), 9591 (gasket 2 mm), 6050/KIN (packing), R901/B7K (with steel cap)

It is suitable for valves and ball valves in hazardous service.

Range of applications

In valves, butterfly valves and ball valves in industrial installations that demand fire safe resistance.

Soot blower set 1 9650/SB1

Combination of Isartherm 6011/A and Rotatherm die-pressed graphite rings for high temperature steam service.

Soot blower set 2 9650/SB2

Combination of Araflon 6426 and Rotatherm die-pressed graphite rings for abrasive service.

EagleBurgmann soot blower packing sets

- Provide a seal during the movement of the lance into the waste gas flue to contain gases and solid particles.
- Support the soot blower lance to reduce deflection (often a considerable load, the lance can be up to 16 m long).
- Strip off the surface solids on the lance after operation in the cleaning cycle.

Parameter	Equipment	Fire safe packing set 9650/FS
Pressure p (bar)	Pumps	260
	Valves	
Sliding velocity v_g (m/s)	Plunger pumps	2
	Mixers, agitators, kneaders, filters	
	Pumps	
	Valves	
Temperature (°C)	Plunger pumps	+550 °C (constant) +550 °C (steam – constant) +600 °C (transient peak)
	Mixers, agitators, kneaders, filters	
pH range		0 ... 14
Application		Valves
Variants		BS 6755 pt 2: 1987
Media resistance		Resistant to almost all organic and inorganic acids, alkalis, oils, and solvents.
Approvals & Certification		ISO 10497
Supply	Form	Customised set
	Stock sizes, mm (other sizes available on request)	Made to order

Parameter	Equipment	Soot blower set 1 9650/SB1	Soot blower set 2 9650/SB2
Pressure p (bar)	Pumps	100	100
	Valves		
Sliding velocity v_g (m/s)	Plunger pumps	2	2
	Mixers, agitators, kneaders, filters		
	Pumps		
	Valves		
Temperature (°C)	Plunger pumps	+550 °C Steam	+250 °C
	Mixers, agitators, kneaders, filters		
pH range		2 ... 12	2 ... 12
Application		Soot blower	Soot blower
Variants			
Media resistance		Especially suitable for hot water and steam. Not suitable for strong acids or strong alkalis.	Recommended for abrasive media.
Approvals & Certification			
Supply	Form	Customised set	Customised set
	Stock sizes, mm (other sizes available on request)	Made to order	Made to order

Injectable packings

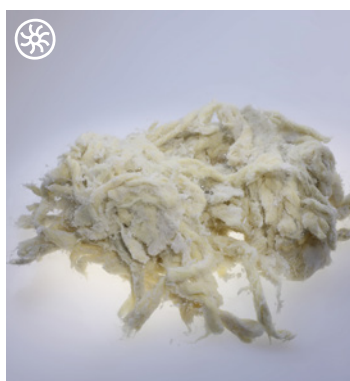

Burajet SCA 8032/SCA

For abrasive applications

Aramid fiber injectable compound with a high performance lubricant. It is ideal for media which has particles or solids, e.g. slurry pumps, refiners, pulpers.

Range of applications

Pumps, valves, mixers, refiners

Burajet SCB 8032/SCB

For general purpose/utility applications

PTFE fiber injectable compound with a high duty graphite based lubricant. Depending on the application a special retention can be necessary. A special retention of two braided packing rings (e.g. Buraflex 2000/HT) or two lipped rings (HPU-hydrolyse resistant polyurethane or FKM-fluorocarbon rubber) can be installed. The Burajet SCB 8032/SCB is suitable for most process applications, providing low friction and a long service life.

Range of applications

Pumps, mixers, filters, kneaders, agitators, valves

Burajet SCH 8032/SCH

For high temperature applications

Graphite injectable compound with a paraffin oil-based lubricant. Depending on the application a special retention can be necessary. A special retention of two braided packing rings (e.g. Isartherm-Flex 6050 or Isartherm K-Flex 6051) can be installed. Developed especially for higher temperature valve applications.

Range of applications

Ideally in valve shafts in flue gas valves

Burajet SCW 8032/SCW

For chemical applications

PTFE fiber injectable compound with excellent lubrication properties provided by PTFE-based additives. Depending on the application a special retention can be necessary. A special retention of two braided packing rings (e.g. Burasoft 6225/L or Buramex SF 6335) or two lipped rings (HPU-hydrolyse resistant polyurethane or FKM-fluorocarbon rubber) can be installed. It is gentle to shaft surfaces and has excellent low friction properties.

Range of applications

Pumps, mixers, kneaders, filters, valves

Burajet injectable packing system offers a wide range of packing materials for most process equipment. The injectable compounds provide superior sealing and low friction performance even in asymmetrical stuffing boxes. In most applications, Burajet can

be retro-fitted to stuffing boxes to replace lantern rings and flush water requirements. The principle advantage of Burajet packing is that once installed it can be refilled without stopping the equipment and interrupting production.

Parameter	Equipment	Burajet SCA 8032/SCA	Burajet SCB 8032/SCB	Burajet SCH 8032/SCH	Burajet SCW 8032/SCW
Pressure p (bar)	Pumps	15	25		25
	Valves	70	75	100	75
	Plunger pumps				
	Fans				
Sliding velocity v_s (m/s)	Mixers, agitators, kneaders, filters	25	25		25
	Pumps	10 (braided end rings) 4 (lip seals)	10 (braided end rings) 4 (lip seals)		10 (braided end rings) 4 (lip seals)
	Valves	2	2	2	2
	Plunger pumps				
Temperature (°C)	Fans				
	Mixers, agitators, kneaders, filters	2	2		2
Temperature (°C)		-10 °C ... + 260 °C	-100 °C ... +250 °C	-30 °C ... +450 °C	-100 °C ... +250 °C
pH range		2 ... 12	0 ... 14	0 ... 14	0 ... 14
Application		Pumps, valves, mixers, kneaders, agitators, refiners	Pumps, valves, mixers, kneaders, agitators, refiners	Butterfly valve stems, waste gas shut-off valves	Pumps, valves, mixers, kneaders, agitators, refiners
Variants					
Media resistance		Resistant to drinking water, food, adhesive media like bitumen or glues, abrasive media like lime, sand, sugar, salt, paints, lacquers, turbine oils.	Resistant to almost all organic and inorganic acids, alkalis, oils and solvents.	Resistant to waste/exhaust gases.	Resistant to almost all organic and inorganic acids, alkalis, oils and solvents.
Approvals & Certification					FDA US 21 CFR 170,3 (i); EPA regulation, article 3, 1935/2004
Supply	Form	Loose-fill fiber compound with braided end rings – Buramex SF 6335 or Araflon 6426 or lip seals – FKM, HPU	Loose-fill fiber compound with braided end rings – Buraflex 2000 or Araflon 6426 or lip seals – FKM, HPU	Loose-fill fiber compound with braided end rings – Isartherm-Flex 6051 or Isartherm-Flex 6050	Loose-fill fiber compound with braided end rings – Buramex SF 6335 or Burasoft 6225/L or lip seals – FKM, HPU
	Contents of boxes	1 kg, 5 kg container	1 kg, 5 kg container	1 kg, 5 kg container	1 kg, 5 kg container

Injectable packings



The rings are manufactured to fit the shaft and the gland housing diameters. An exact measurement is required (to 0.1 mm) in order to machine the lip seals to the correct dimensions

Note

Use careful handling when assembling. The profile ring can be split using a single cut to ease installation around the shaft. It can then be rejoined using acrylo-cyanate adhesive.

Machined rings should be selected to comply with the operating parameters of the Burajet injectable fiber packing and to meet the relevant process operating conditions. Chemical stability is dependent on process media.



Burajet injection gun 8032/HHP

Hydraulic injection gun for easy injection of Burajet fiber packing compounds. The change to an injection system is easy and without great technical demands; one gun can be used for many installations on site.



Burajet chamber rings 8032/AU ... /FKM

Profiled end rings with inner lip seal provide excellent retention of Burajet injectable fiber packing – 8032/SCA ... SCW. They reduce the risk of media contamination but have more limited compensation for shaft radial movement than braided packing rings.

Burajet AU lip seals are made from high density Polyurethane, hydrolysis resistant. Burajet FKM lip seals are made from Fluoropolymer.

Injection gun can be supplied separately or in a convenient wheeled workshop case complete with adapters and quick-release couplers.

Range of applications

For supplying and topping up fiber injectable compound

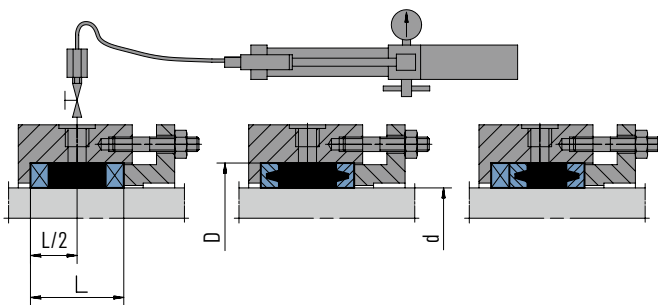

Method 1

Retention by means of braided packing rings.

Method 2

Retention by means of machined lip seals.

Method 3

Retention by braided packing ring and machined lip seals.

Parameter	Equipment	Burajet chamber ring 8032/AU	Burajet chamber ring 8032/FKM
Pressure p (bar)	Pumps	25	25
	Valves	25	25
	Mixers, agitators, kneaders, filters	25	25
Sliding velocity v_s (m/s)	Pumps	4	4
	Valves	4	4
	Mixers, agitators, kneaders, filters	4	4
Temperature (°C)		-30 °C ... +110 °C	-20 °C ... +220 °C
pH range		2 ... 12	2 ... 12
Application		Pumps, valves, mixers, kneaders, agitators, refiners	Pumps, valves, mixers, kneaders, agitators, refiners
Media resistance		Resistant to all media except strongly oxidising media like hot sulphuric or nitric acid.	
Approvals & Certification			FDA approval
Supply	Form	2 rings per set	2 rings per set

Burajet has been used successfully in paper mills around the world to reduce downtime and operating costs. For example, one paper mill has retrofitted all of its refiners with Burajet. In each refiner the lantern ring and flush water were removed and the existing connection was converted to a Burajet injection port. There was no need to reconnect flush water as Burajet can work successfully at normal operating temperatures without it. The paper mill is now saving in excess of US\$ 20,000 per refiner per year in water costs. It is also benefiting from reduced process interruptions since the Burajet can be repacked while the refiner is running.

Non-ceramic fibers

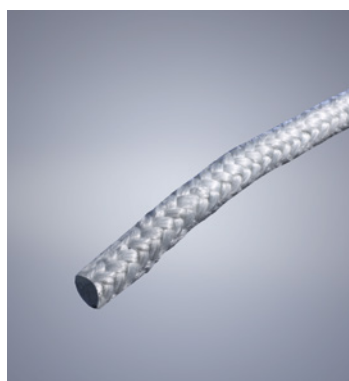

BuraGlas 9480

BuraGlas glass-fiber packing is suitable for sealing of vessels, coal mills, industrial heaters, oven doors, hatches and covers as well as for thermal isolation of pipe flanges, pipe bushings etc. All materials are non-flammable.

BuraGlas 9480

Square braided packing made from texturised glass yarn.

BuraGlas 9480/P

Square braided packing made from texturised glass yarn and graphite impregnation.

BuraGlas R 9472

Glass fiber round section braided packing for static sealing applications.

BuraGlas R 9472

Round braided packing made from texturised glass yarn.

BuraGlas R 9472/P

Round braided packing made from texturised glass yarn and graphite impregnation.

BuraGlas INC 7260/INC

Core made of HT glass fiber yarn with Inconel® wire reinforcement and mica impregnation. Suitable for temperatures up to 750 °C.

Glass fiber square braided packing for sealing of vessels, coal mills, heaters, oven doors. For thermal isolation of pipe flanges. All materials are free of non-flammable materials.

Application

Static sealing and thermal isolation.

Note

The indicated values for temperatures can be taken as sustained temperatures even in case of air contact.

BuraGlas HT 9483/HT

Core made of HT glass fiber yarn with Inconel® wire reinforcement. Suitable for temperatures up to 800 °C.

Glass fiber square braided packing for sealing of vessels, coal mills, heaters, oven doors. For thermal isolation of pipe flanges. All materials are free of non-flammable materials.

Application

Static sealing and thermal isolation.

Range of applications

Static high temperature seal, excellent for boilers, coal pulverizing mills, industrial furnaces, butterfly valves and covers. Also provides thermal insulation for pipes and pipe openings, etc.

Parameter	BuraGlas 9480	BuraGlas R 9472	BuraGlas INC 7260/INC	BuraGlas HT 9483/HT	BuraGlas HT-SI 9486
Pressure p (bar)	10	10	10	10	10
Sliding velocity v _s (m/s)					1
Temperature (°C)	+550 °C	+550 °C	+750 °C	+800 °C	+1,100 °C
pH range	5 ... 9	5 ... 9	5 ... 9	5 ... 9	5 ... 9
Variants (made to order)	BuraGlas 9480/P (with graphite impregnation)	BuraGlas RP 9472/P (with graphite impregnation)	BuraGlas 7260 (without Inconel® wire reinforcement)		Square section or round section
Application	For sealing of vessels, coal mills, heat exchangers, oven doors	For sealing of vessels, coal mills, heat exchangers, oven doors	For sealing of vessels, coal mills, heat exchangers, oven doors	For sealing of vessels, coal mills, heat exchangers, oven doors	For sealing of boilers, heat exchangers, oven doors
Media resistance	Resistant to water, steam, oil, neutral and dry gases.	Resistant to water, steam, oil, neutral and dry gases.	Resistant to water, steam, oil, neutral and dry gases.	Resistant to water, steam, oil, neutral and dry gases.	Resistant to water, steam, oil, neutral and dry gases.
Approvals & Certification	Hydrolytische Klasse 1 to DIN 12 111				
Supply	Square section Braided packing 4 mm < 60 mm (<120 mm on request) Supplied by the meter	Round section Braided packing 4 mm < 50 mm dia. (<120 mm on request) Supplied by the meter	Square section 4 mm < 60 mm section (<120 mm size on request) Supplied by the kg	Square section 4 mm < 60 mm section (<120 mm size on request) Supplied by the meter	Square or round section Braided packing 5 mm < 50 mm section (square or round) Supplied by the meter

Non-ceramic fibers

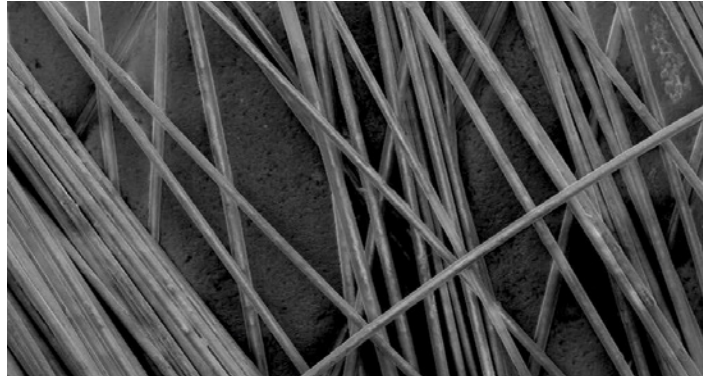

BuraGlas HT-SI 9486

Ideal for extreme high temperature static applications.

BuraGlas HT-SI 9486 is made from high quality silicic acid yarn capable of withstanding extremely high temperatures. This is augmented by a special impregnation which gives optimal density resulting in excellent sealing characteristics. Due to its high quality engineered construction and composition, the packing also shows good chemical resistance, high mechanical strength and excellent physical properties.

Range of applications

This compound is excellent for static applications in boilers, furnaces or heat exchangers. Also for thermal insulation.

BuraGlas glass packings

EagleBurgmann glass packings have been used for many years in applications such as oven door seals, ductwork seals, and molten metal crucible seals. In line with the EagleBurgmann philosophy of manufacturing environmentally safe products all of the BuraGlas range is now manufactured from materials and fibers which comply with World Health Organisation (WHO) safety requirements.

Environmental safety and WHO requirements

The safety of personnel is critical in any day-to-day activity in industry which has led to worldwide regulation and banning of certain materials in the past few years, e.g. asbestos.

There is an ongoing review around the world concerning the possible carcinogenic effects of various other fiber materials such as man-made mineral fibers (commonly called ceramic fibers).

This is due to the realisation that it is the physical size of fibers and not just their chemical composition which can create health problems for people exposed to them.

The carcinogenic effect of fibers, regardless of whether they are organic or inorganic, natural or synthetic, is based on the size ratio and the biological resistance of the fibers. It has been established that the critical size range for such fibers is

- length $l > 5 \mu\text{m}$
- and diameter $d < 3 \mu\text{m}$
- and a size ratio $l : d = \text{more than } 3 : 1$

Such hazardous fibers are classified according to the **EC-regulations 97/69/EC, 67/548/EEC and TRGS 905** and are sometimes referred to as **WHO – fibers**.

Packing cartridge units

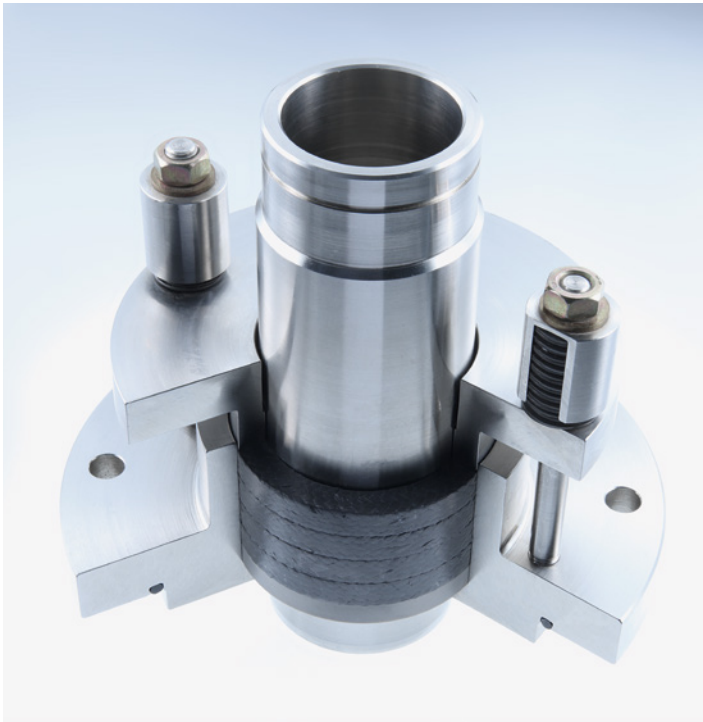

Packing cartridge unit 9984

Packing cartridges combine quick and easy installation with robust simple construction to provide minimum downtime and maximum reliability in critical process applications. They are used in agitators, mixers, kneaders, filters and pumps.

Cartridges can be used to compensate for large axial and radial movements. Depending on the application, they can also be used for dry running. Selection of packing material depends upon process media and operating conditions. Packing cartridges are manufactured to individual requirements but are regularly supplied to fit into DIN/ASME standard equipment e.g. agitators. The cartridge unit can be supplied with live-loading and additional bellows containment as required for maximum environmental safety.

Cartridges are available with

- Integral shaft bearing
- Lubrication
- Inert gas barrier
- Shaft sleeves with chromium oxide coating or tempered for abrasion protection
- "Floating" design for excessive shaft movements

We know from experience the engineering design required to make a packing cartridge work successfully. Please contact your local EagleBurgmann sales office for assistance in selecting the best design for your application.

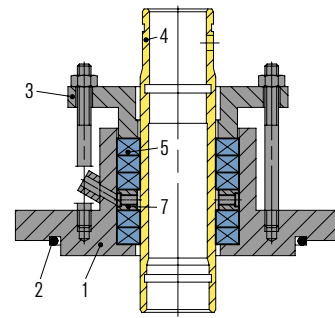

- 1 Stuffing box housing
- 2 O-ring or Statotherm profile ring
- 3 Gland follower
- 4 Shaft sleeve
- 5 Packing set
- 7 Lantern ring

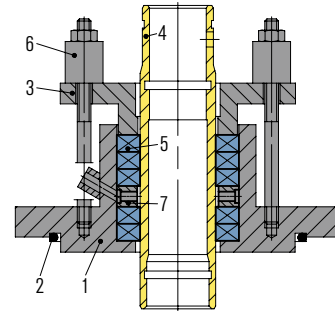

- 1 Stuffing box housing
- 2 O-ring or Statotherm profile ring
- 3 Gland follower
- 4 Shaft sleeve
- 5 Packing set
- 6 Guide sleeve for spring washers
- 7 Lantern ring

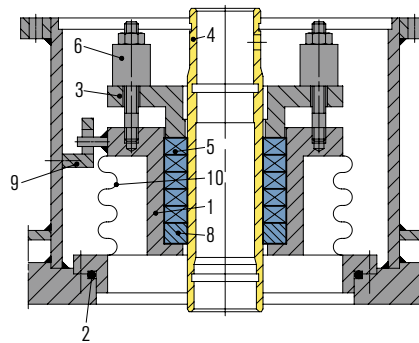

- 1 Stuffing box housing
- 2 O-ring or Statotherm profile ring
- 3 Gland follower
- 4 Shaft sleeve
- 5 Packing set
- 6 Guide sleeve for spring washers
- 8 Carbon ring
- 9 Anti-rotation device
- 10 Containment bellows

Typical applications

Packing cartridges are ideal for applications which require extended service life and fast seal replacement to reduce downtime, for example:

- A major chemical plant needed to improve Mean Time Between Repair (MTBR) of a critical plunger pump. Service life was doubled to 6 months by fitting a special packing cartridge equipped with 2 independent live-loaded sealing sets. The packing set on the high pressure side was fitted with an additional diffusion barrier and there was also an intermediate lantern ring water barrier before the low pressure packing set. The customer reduced external pump leakage to zero, extended operating life, and reduced downtime when the pump eventually needed servicing.

- A refinery wanted to increase production but was prevented from doing so because the decoker process took too much time. The problem was identified as the reliability and service time required by the high pressure hydraulic discharge pumps. These pumps were handling hot, liquid coke at 330 bar and 485 °C.

The pumps were retro-fitted with EagleBurgmann packing cartridges and service life jumped from 3 < 6 months up to 24 months. The refinery now achieves a much higher production throughput with a safer environment (through reduced leakage) and reduced downtime.

The EagleBurgmann packing cartridge offers a unique customised sealing solution for critical equipment and provides the customer with more reliability and extended operating life.

Live-loading system

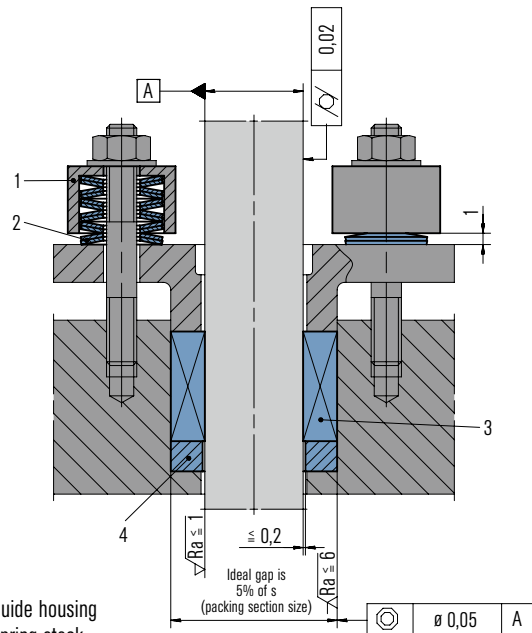
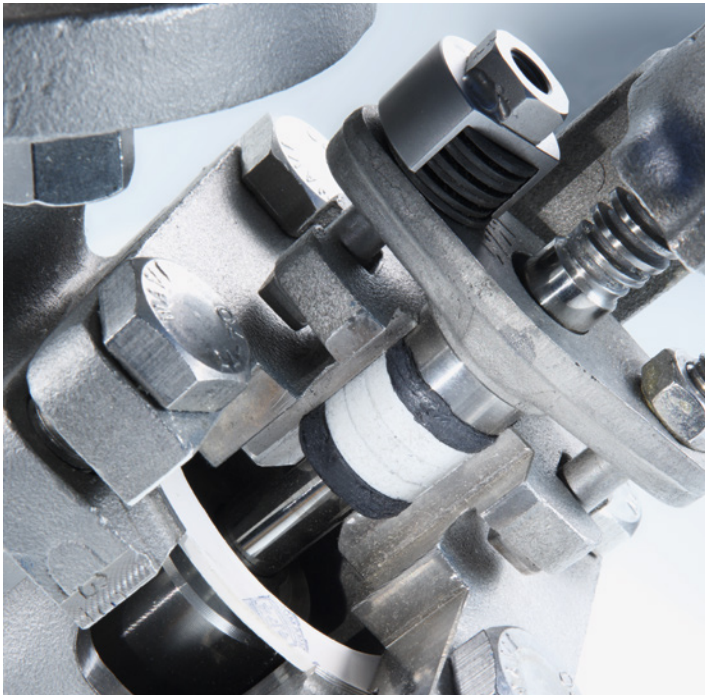

- 1 Guide housing
- 2 Spring stack
- 3 Sealing set
- 4 Make-up bush

The EagleBurgmann live-loading system provides a defined, permanent pre-load onto the sealing set, thus offering optimum sealing under the most severe operating conditions. The system is ideal for valves which are critical for plant operation or are in "difficult to get to" locations for maintenance.

The systems can be fitted to new valves or retro-fitted to existing valves or equipment such as mixers.

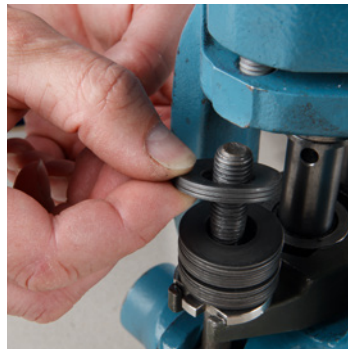

EagleBurgmann live-loading systems ensure

- A constant self-adjusting sealing force on the packing set – ideal for applications which have high thermal and/or pressure cycle rates.
- Leakage rates which are well below the levels demanded by standards such as TA-Luft, API 622, and ISO 15848.
- Reduced maintenance requirements since no regular manual adjustment of the packing set is required.
- Extended packing set life.

Live-loading systems can be quickly fitted to an existing valve. The required spring loading etc. is calculated by our application engineers from your site measurements.



The gap between the spring stack cover and the gland plate is pre-set to 1 mm on initial installation.

During normal operation the packing set wears. The gap is readjusted back to 1 mm when it reaches 3 mm.

Please contact your local EagleBurgmann sales office for more information on these products and for assistance in measuring and preparing valves for live-loading service.

Packing workshop tools



Packing extractor 9611

A robust, handy tool for packing removal from pumps, agitators, valves, etc. Its durability has been proven over time with many thousands in use every day around the world. The extractor drastically reduces the time needed to replace packing and prevents damage to shafts when used correctly. The tool has a flexible, torque-resistant shaft which enables secure and complete removal of old packing rings even in difficult-to-reach installations.

Range of applications

Safe and easy removal of the old packing when required.

The tool is available in 4 sizes.

Diameter	Length
3.5 mm	120 mm
6 mm	160 mm
8 mm	210 mm
10 mm	260 mm



Joudol »SM« 8152

Universal high duty lubricant and anti-seize agent with a graphite base. Prevents seals from sticking and baking to surface. Keeps screw threads movable.

Applications

Lubricant and anti-seize agent

Design

Mixture based on graphite

Technical Data

Resistant from $-200\text{ }^{\circ}\text{C}$ up to $+500\text{ }^{\circ}\text{C}$

Supply Form

Can 1 kg

Tube 230 g



Packing cutters 9612 ... 9616

Easy to handle special cutting tools which ensure that each ring is cut-to-length correctly every time.

Makes the cutting of packing rings with a straight cut (pumps) or slanted cut at 45° (valves) simple just by aligning the sliding scales to match the shaft diameter to packing size.

No waste due to badly cut packing; ensures clean cut ends with a precise angle every time. The cutter comes with an adjustable stop, packing clamp, and scale (extension scales are available for larger rings: part no. 9612/G).

Range of applications

For cutting packing cords to length with a straight cut



Pump packing cutter 9612

For cutting rings with a straight cut

Valve packing cutter 9616

For cutting rings with a slanted (45°) cut

Range of applications

For cutting packing cords to length with a slanted cut

Graphite rings – design and installation

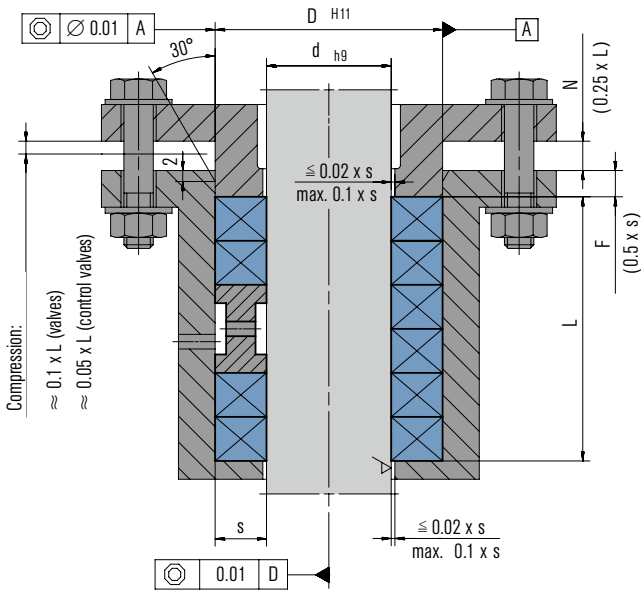

Surface finish recommendation

$Rz \leq 1.6 \mu\text{m}$ on shafts, spindles in general
 $Rz \leq 0.6 \mu\text{m}$ for control valve spindles
 $Rz \leq 6 \mu\text{m}$ for stuffing box housings

Radial shaft movement ($< 2\% \times s$) to achieve low leakage at vacuum.

Rotatherm pure graphite sealing rings allow a considerable reduction of the packing height due to its homogenous structure and high density. In existing equipment the stuffing box space can be reduced as required by the insertion of a spacer bush at the bottom of the stuffing box.

In control valves and applications where low and uniform frictional forces are required, a specific radial sealing pressure on the spindle must not be exceeded.

Rotatherm rings are made exactly to the dimensions of the stuffing box.

The spindle and the gland space must be clean and in first class condition (an essential requirement for correct operation and a long service life).

The radial shaft movement should be lower than $1.02 \times s$.

Insert the Rotatherm rings into the stuffing box. With split rings, stagger the joints radially.

Set the valve spindle position so that after partial compression of the packing the spindle can be rotated inward toward the stuffing box.

The required compression of the packing set should be carried out in two stages:

1. Tighten the gland $\frac{3}{4}$ of the required compression distance, then actuate the spindle inward toward the stuffing box.
2. Complete the compression of the gland follower and the packing set. The valve is now ready for operation.

Note

This procedure can also be used for pumps, valves, mixers using braided packing, non-woven sets, or graphite rings.

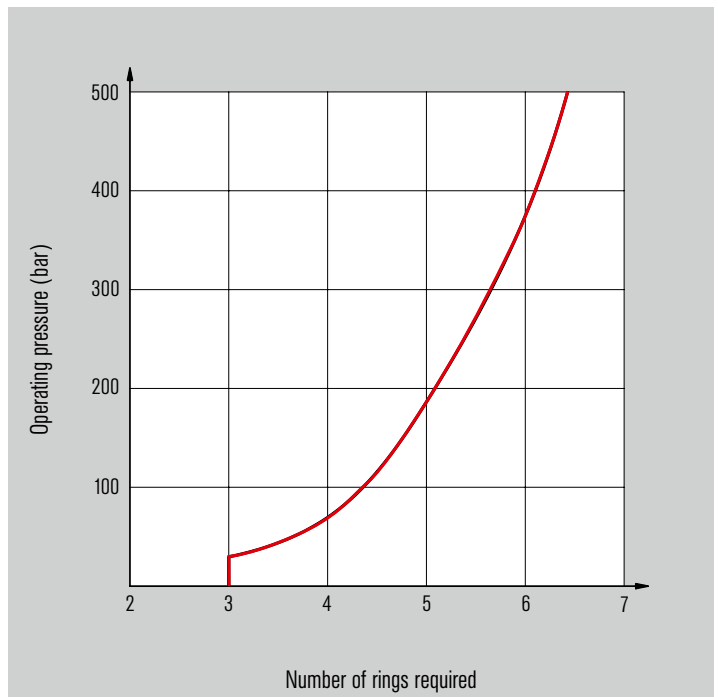
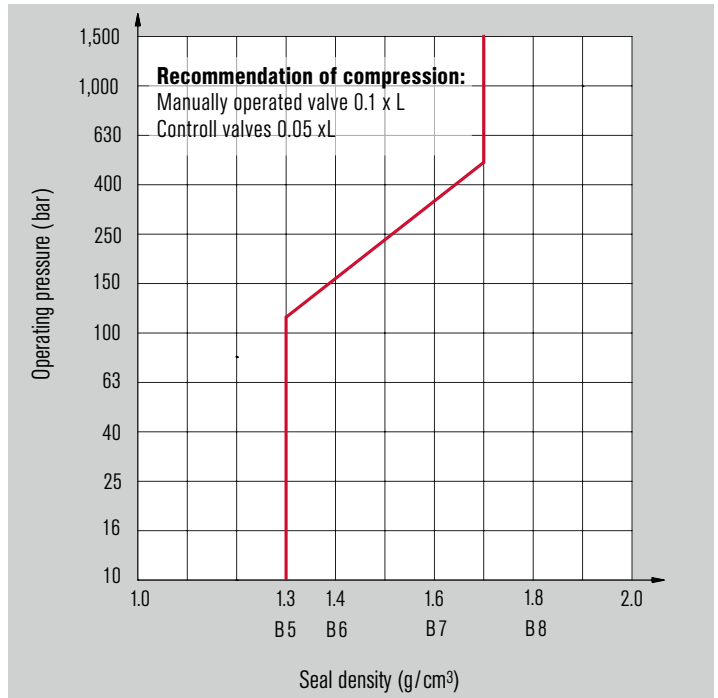

Cutting packing rings



EagleBurgmann packing cutters (9612, 9616) ensure precisely cut rings. If no cutter is available, proceed as follows. The cutting length L is dependent on the shaft diameter d and the packing width s according to the following formula:

$$L_M = (d + s) \cdot x \cdot \pi \text{ (mm)}$$

where x = allowance factor

$x = 1.07$ for shaft dia. < 60 mm
 $x = 1.05$ for shaft dia. ≥ 60 mm < 100 mm
 $x = 1.03$ for shaft dia. more than ≥ 100 mm

The use of allowance factors is required to compensate for shrinking of the packing in operation. Large section-size packing in combination with different packing materials (harder or softer) can affect the effectiveness of the allowance factor unfavourably. We will gladly advise you in such cases.

Example:

Shaft diameter $d = 60$ mm
 Stuffing box diameter $D = 80$ mm
 Packing thickness s :
 $s = \frac{D - d}{2} = \frac{80 - 60}{2} = 10$ mm

Cutting length L_M :
 $L_M = (d + s) \cdot 1.07 \cdot \pi$
 $= (60 + 10) \cdot 1.07 \cdot \pi$
 ~ 235 mm

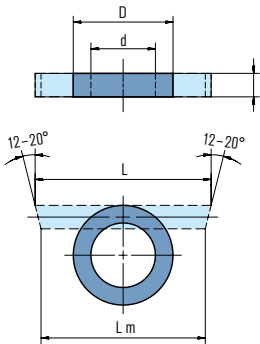

Straight cuts (pumps, rotating shafts)

For rotating shafts we generally recommend cutting the packing straight at right angles to the shaft. This applies in particular to pump applications. To achieve parallel contact of the cut ends without any gap when the packing ring is closed, the allowance angle on both cut ends should equal approx. $12^\circ \dots 20^\circ$.

If you apply the above formula, or if you use the EagleBurgmann packing cutter, the cut ring will be slightly over-long.

In conjunction with the straight cut this results in a slight tensioning of the ring against the stuffing box outer wall, thus preventing co-rotation of the packing rings (spinning) as well as preventing leakage past the stuffing box wall.

Slanted cuts (valves)

A slanted cut is recommended for this duty because it is easier to install, since valve packings are usually stiffer. Unlike pumps, there is no need for any supporting effect.

Note

The cut ends of dry packings fray out easily; you should therefore secure the ends with adhesive tape prior to cutting. We also recommend a slanted cut for plunger pumps as well as for slow running shafts, e.g. in agitators, mixers, and kneaders.

Packing installation – preparation

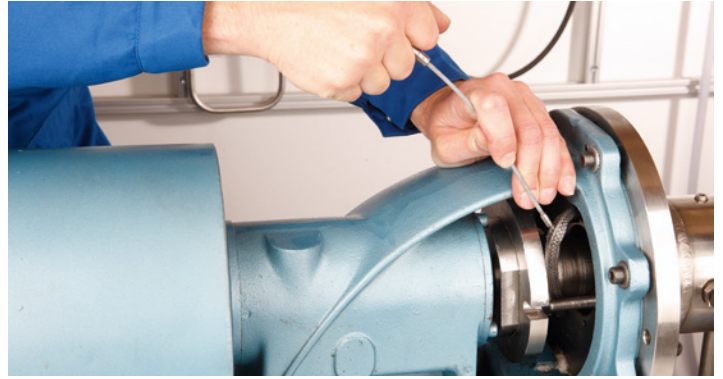

Removing the old packing

After isolating and releasing pressure on the equipment, remove the gland plate/follower. Use the packing extractor (9611) to remove the old packing rings and debris right down to the bottom of the stuffing box.

Preparing the stuffing box

Clean the stuffing box and the spindle or shaft surface thoroughly. Replace any corroded spindles or worn shafts and protective sleeves. Check the shaft bearing and its concentricity.

To reduce an excessively large gap, insert a washer or disk into the bottom of the stuffing box in order to prevent the packing material being extruded into the gap. An alternative is to use suitable packing with anti-extrusion reinforced corners for header rings.

If the bottom of the stuffing box or contact surface of the gland is conical we recommend machining it square. The wedge effect would otherwise increase the contact pressure, leading to excessive wear of packing and sliding surfaces.

Selecting the grade and size of packing

Before installing the packing, check once again that you have chosen a suitable packing for the operating conditions.

For valves only use packing with the exact size cross section, preferably in pre-formed ring form.

For pumps we recommend using a slightly under-sized packing cross-section (of approx. $0.1 < 0.6$ mm according to the cross-section) This provides the necessary leakage gap between the shaft and the packing ring. The gap is essential to ensure a higher rate of start-up leakage necessary for lubrication and for the dissipation of frictional heat. This must be taken into consideration particularly with PTFE and PTFE impregnated packings (risk of burning). The use of over-size packings is not recommended because the packing cross section reverts to its original size when the cut packing is inserted into the stuffing box.

Coating recommendations for shafts and their protective sleeves

Plasma flame coating process

Aluminium oxide

HRC	HV	Coating properties
60 - 65	3,000	High wear resistance, electrical insulator, corrosion resistance.

Chromium oxide

HRC	HV	Coating properties
60 - 65	2,500	Good chemical resistance, extremely resistant to wear, withstands abrasion and high temperatures.

Thermal spray coating process

Nickel chromium – Boron silicon alloys

HRC	Coating properties
62 - 65	Fusion-bonded, highly wear resistant coatings, resistant to cavitation, erosion and corrosion.

Hard chromium plating is not suitable due to the risk of flaking and sub-surface corrosion.

Packing installation



Die-pressed rings should be carefully twisted open in an axial and radial direction just far enough to enable them to be slipped over the shaft. Excessive bending of the rings can cause structural damage through kinking.



Using assembly shells, or the gland follower, each ring must be inserted separately into the stuffing box starting with the butted together cut ends. Pointed objects must never be used for this operation because there is a risk of damaging the shaft or deforming the packing material.



Insert more rings into the stuffing box making sure that each cut joint is at 90° to the previous ring joint. Rings should be added until the gland projects (for guidance) into stuffing box compartment by at least 1/4 (for valves) or approx. 1/2 (for pumps) of the packing width "s". Press the rings home with the gland and tighten the nuts hand-tight. If there is a lantern ring, check that it is correctly positioned in relation to the inlet connection after the gland has been tightened.

Packing cross-section

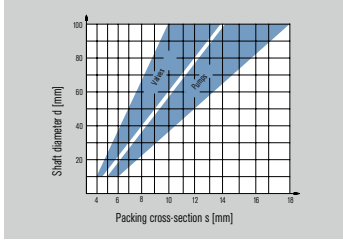

For pumps we recommend a packing cross-section in the range of $s = 1.4 - 1.8 \cdot \sqrt{d}$.

For valves in the range of $s = 1.0 - 1.4 \cdot \sqrt{d}$.

Number of packing rings

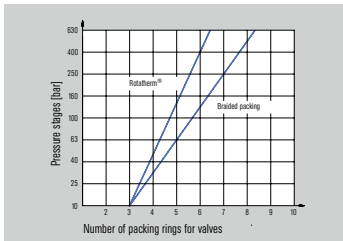
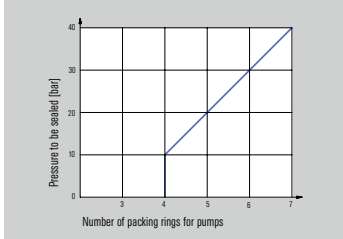

Sliding velocity v_g

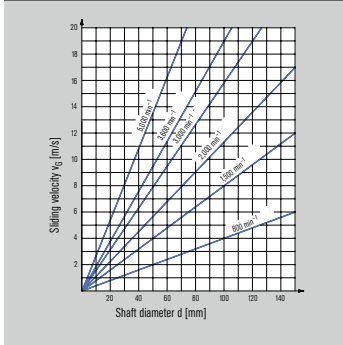

The sliding velocity can be derived from the diagram as a function of the shaft diameter and the shaft speed. The maximum admissible sliding velocities for the various packing grades are listed in the overview on the front cover fold-out page.

Formula:

$$v_g = \frac{d \cdot \pi \cdot n}{60,000} \text{ [m/s]}$$

Commissioning

Starting up – packings

Centrifugal pumps

In centrifugal pumps, stuffing box packings have the function of limiting but not totally preventing the escape of medium. A lubricant is required in order to reduce shaft wear to a minimum and to dissipate the heat produced by friction.

For this reason the stuffing box gland should be tightened only lightly by hand prior to putting into operation. If the pressure is applied using a torque limiting wrench, we recommend that a pre-tensioning value between 1.1 < 1.6 of operating pressure is used.

A high initial rate of leakage should be permitted, particularly with PTFE and PTFE impregnated packings (50 < 200 drops per minute depending upon the medium and the sliding velocity). During the running-in phase of approx. 30 minutes, the minimum leakage rate must be set by tightening the gland nuts uniformly in steps of approx. 1/6 of a turn each.

The stuffing box temperature should not rise abnormally (approx. 20 °C < 60 °C above the medium temperature is permitted). If there is a sudden jump in temperature and a notable reduction in leakage, the gland must be slackened immediately and the running-in operation repeated.

The attainable leakage values are conditional on, among other things, the medium, pressure, temperature, leakage gap, sliding velocity, shaft run-out, and the packing material used.

In the event of higher peripheral leakage (leakage around the stuffing box outer wall) the packing rings must be compressed briefly by high pressure with the pump at a standstill. Then release the gland and repeat the running-in operation.

Valves

For valves the seal should be leak free. To achieve this, the stuffing box gland must be tightened in accordance with the following values depending on the operating pressure p_1 and the medium (liquid or gaseous) prior to pressurising the system:

Liquid media

Up to 40 bar: $2 \times p_1$ (at least 5 N/mm²)
 Above 40 bar: $1.5 \times p_1$

Gaseous media

Up to 40 bar: $5 \times p_1$ (at least 10 N/mm²)
 >40 ... 200 bar: $2.5 \times p_1$
 Above 200 bar: $1.5 \times p_1$

Avoid tilting or misaligning the gland. For uniform and controlled pre-tensioning of the packing by the stuffing box gland we always recommend the use of a torque limiting wrench or similar tool.

Control valves require delicate setting for zero leakage under operating conditions. We recommend that the spindle is actuated several times during the setting process to check operation using normal actuation forces. It is recommended that a dry graphite powder is rubbed over the spindle surface before installing graphite-based packings.

In addition to these general notes, separate instructions are available for specific packing materials and special applications.

For expected or occurring frictional forces and torques the following formula can be consulted:

$$FR = \frac{pB \times d \times \pi \times h}{\mu k}$$

FR = Frictional force of stem (N)
 pB = Axial gland pressure (N/mm²)
 d = Diameter of stem (mm)
 $\pi = 3.14$
 h = Uncompressed height of sealing set (mm)
 μk = Frictional value x Power transmitting factor

Plunger pumps

The guidelines for valves apply in general for the installation of packing material and start-up operations for plunger pumps.

Reliable sealing of plunger pumps in the pressure range above 100 bar requires the installation of special packing sets. We will send you recommendations to meet your operating conditions upon request.

Compression packings – density and weight table

Length/meters per kilogram weight (tolerance: ±5 %)

Packing style	Spec. weight g/cm ³	Packing size mm																
		3	4	5	6	8	10	12	12.7	14	15	16	18	19	20	22	24	25
2000/HT	1.25	88.89	50.00	32.00	22.22	12.50	8.00	5.56	4.96	4.08	3.56	3.13	2.47	2.22	2.00	1.65	1.39	1.28
4001	1.20	92.59	52.08	33.33	23.15	13.02	8.33	5.79	5.17	4.25	3.70	3.26	2.57	2.31	2.08	1.72	1.45	1.33
4002	1.20	92.59	52.08	33.33	23.15	13.02	8.33	5.79	5.17	4.25	3.70	3.26	2.57	2.31	2.08	1.72	1.45	1.33
4003	1.20	92.59	52.08	33.33	23.15	13.02	8.33	5.79	5.17	4.25	3.70	3.26	2.57	2.31	2.08	1.72	1.45	1.33
5846	1.30	85.47	48.08	30.77	21.37	12.02	7.69	5.34	4.77	3.92	3.42	3.00	2.37	2.13	1.92	1.59	1.34	1.23
6011/A	1.15	96.62	54.35	34.78	24.15	13.59	8.70	6.04	5.39	4.44	3.86	3.40	2.68	2.41	2.17	1.80	1.51	1.39
6050	1.15	96.62	54.35	34.78	24.15	13.59	8.70	6.04	5.39	4.44	3.86	3.40	2.68	2.41	2.17	1.80	1.51	1.39
6050/KIN	1.20	92.59	52.08	33.33	23.15	13.02	8.33	5.79	5.17	4.25	3.70	3.26	2.57	2.31	2.08	1.72	1.45	1.33
6051	1.10	101.01	56.82	36.36	25.25	14.20	9.09	6.31	5.64	4.64	4.04	3.55	2.81	2.52	2.27	1.88	1.58	1.45
6065	1.65	67.34	37.88	24.24	16.84	9.47	6.06	4.21	3.76	3.09	2.69	2.37	1.87	1.68	1.52	1.25	1.05	0.97
6225/L	1.72	64.60	36.34	23.26	16.15	9.08	5.81	4.04	3.60	2.97	2.58	2.27	1.79	1.61	1.45	1.20	1.01	0.93
6226/NQ	1.75	63.49	35.71	22.86	15.87	8.93	5.71	3.97	3.54	2.92	2.54	2.23	1.76	1.58	1.43	1.18	0.99	0.91
6226/L	1.72	64.60	36.34	23.26	16.15	9.08	5.81	4.04	3.60	2.97	2.58	2.27	1.79	1.61	1.45	1.20	1.01	0.93
6230	1.58	70.32	39.56	25.32	17.58	9.89	6.33	4.40	3.92	3.23	2.81	2.47	1.95	1.75	1.58	1.31	1.10	1.01
6230/SL	1.62	68.59	38.58	24.69	17.15	9.65	6.17	4.29	3.83	3.15	2.74	2.41	1.91	1.71	1.54	1.28	1.07	0.99
6232	1.45	76.63	43.10	27.59	19.16	10.78	6.90	4.79	4.28	3.52	3.07	2.69	2.13	1.91	1.72	1.42	1.20	1.10
6335	1.35	82.30	46.30	29.63	20.58	11.57	7.41	5.14	4.59	3.78	3.29	2.89	2.29	2.05	1.85	1.53	1.29	1.19
6426	1.38	80.52	45.29	28.99	20.13	11.32	7.25	5.03	4.49	3.70	3.22	2.83	2.24	2.01	1.81	1.50	1.26	1.16
6430/K1	1.48	75.08	42.23	27.03	18.77	10.56	6.76	4.69	4.19	3.45	3.00	2.64	2.09	1.87	1.69	1.40	1.17	1.08
6430/K2	1.52	73.10	41.12	26.32	18.27	10.28	6.58	4.57	4.08	3.36	2.92	2.57	2.03	1.82	1.64	1.36	1.14	1.05
6435	1.32	84.18	47.35	30.30	21.04	11.84	7.58	5.26	4.70	3.87	3.37	2.96	2.34	2.10	1.89	1.57	1.32	1.21

Weight/kg per meter/length (tolerance: ±5 %)

Packing style	Spec. weight g/cm ³	Packing size mm																
		3	4	5	6	8	10	12	12.7	14	15	16	18	19	20	22	24	25
2000/HT	1.25	0.0113	0.0200	0.0313	0.0450	0.0800	0.1250	0.1800	0.2016	0.2450	0.2813	0.3200	0.4050	0.4513	0.5000	0.6050	0.7200	0.7813
4001	1.20	0.0108	0.0192	0.0300	0.0432	0.0768	0.1200	0.1728	0.1935	0.2352	0.2700	0.3072	0.3888	0.4332	0.4800	0.5808	0.6912	0.7500
4002	1.20	0.0108	0.0192	0.0300	0.0432	0.0768	0.1200	0.1728	0.1935	0.2352	0.2700	0.3072	0.3888	0.4332	0.4800	0.5808	0.6912	0.7500
4003	1.20	0.0108	0.0192	0.0300	0.0432	0.0768	0.1200	0.1728	0.1935	0.2352	0.2700	0.3072	0.3888	0.4332	0.4800	0.5808	0.6912	0.7500
5846	1.30	0.0117	0.0208	0.0325	0.0468	0.0832	0.1300	0.1872	0.2097	0.2548	0.2925	0.3328	0.4212	0.4693	0.5200	0.6292	0.7488	0.8125
6011/A	1.15	0.0104	0.0184	0.0288	0.0414	0.0736	0.1150	0.1656	0.1855	0.2254	0.2588	0.2944	0.3726	0.4152	0.4600	0.5566	0.6624	0.7188
6050	1.15	0.0104	0.0184	0.0288	0.0414	0.0736	0.1150	0.1656	0.1855	0.2254	0.2588	0.2944	0.3726	0.4152	0.4600	0.5566	0.6624	0.7188
6050/KIN	1.20	0.0108	0.0192	0.0300	0.0432	0.0768	0.1200	0.1728	0.1935	0.2352	0.2700	0.3072	0.3888	0.4332	0.4800	0.5808	0.6912	0.7500
6051	1.10	0.0099	0.0176	0.0275	0.0396	0.0704	0.1100	0.1584	0.1774	0.2156	0.2475	0.2816	0.3564	0.3971	0.4400	0.5324	0.6336	0.6875
6065	1.65	0.0149	0.0264	0.0413	0.0594	0.1056	0.1650	0.2376	0.2661	0.3234	0.3713	0.4224	0.5346	0.5957	0.6600	0.7986	0.9504	1.0313
6225/L	1.72	0.0155	0.0275	0.0430	0.0619	0.1101	0.1720	0.2477	0.2774	0.3371	0.3870	0.4403	0.5573	0.6209	0.6880	0.8325	0.9907	1.0750
6226/NQ	1.75	0.0158	0.0280	0.0438	0.0630	0.1120	0.1750	0.2520	0.2823	0.3430	0.3938	0.4480	0.5670	0.6318	0.7000	0.8470	1.0080	1.0938
6226/L	1.72	0.0155	0.0275	0.0430	0.0619	0.1101	0.1720	0.2477	0.2774	0.3371	0.3870	0.4403	0.5573	0.6209	0.6880	0.8325	0.9907	1.0750
6230	1.58	0.0142	0.0253	0.0395	0.0569	0.1011	0.1580	0.2275	0.2548	0.3097	0.3555	0.4045	0.5119	0.5704	0.6320	0.7647	0.9101	0.9875
6230/SL	1.62	0.0146	0.0259	0.0405	0.0583	0.1037	0.1620	0.2333	0.2613	0.3175	0.3645	0.4147	0.5249	0.5848	0.6480	0.7841	0.9331	1.0125
6232	1.45	0.0131	0.0232	0.0363	0.0522	0.0928	0.1450	0.2088	0.2339	0.2842	0.3263	0.3712	0.4698	0.5235	0.5800	0.7018	0.8352	0.9063
6335	1.35	0.0122	0.0216	0.0338	0.0486	0.0864	0.1350	0.1944	0.2177	0.2646	0.3038	0.3456	0.4374	0.4874	0.5400	0.6534	0.7776	0.8438
6426	1.38	0.0124	0.0221	0.0345	0.0497	0.0883	0.1380	0.1987	0.2226	0.2705	0.3105	0.3533	0.4471	0.4982	0.5520	0.6679	0.7949	0.8625
6430/K1	1.48	0.0133	0.0237	0.0370	0.0533	0.0947	0.1480	0.2131	0.2387	0.2901	0.3330	0.3789	0.4795	0.5343	0.5920	0.7163	0.8525	0.9250
6430/K2	1.52	0.0137	0.0243	0.0380	0.0547	0.0973	0.1520	0.2189	0.2452	0.2979	0.3420	0.3891	0.4925	0.5487	0.6080	0.7357	0.8755	0.9500
6435	1.32	0.0119	0.0211	0.0330	0.0475	0.0845	0.1320	0.1901	0.2129	0.2587	0.2970	0.3379	0.4277	0.4765	0.5280	0.6389	0.7603	0.8250

Contents of box (standard braid)

Diameter	Weight
Up to 6 mm	1 kg
Up to 10 mm	2 kg
Up to 13 mm	3 kg
From 14 mm	5 kg



Additional products and services



Gasket cutting centers

EagleBurgmann has strategically located gasket cutting centers around the world offering 24 hour turnaround times for custom-made gaskets. The state-of-the-art CNC machines offer flexibility and low cost in either producing a single gasket or small to medium size batch quantities.



The benefits to you are

- No tooling costs.
- Almost any gasket material can be cut into the most intricate shape.
- Reduce your spares stock since delivery can be made in hours (by prior arrangement).
- Reduce downtime caused by non-availability of critical gasket components.

Sheet gasket materials

Burasil aramid, Buratherm aramid/graphite, Burachem modified PTFE and Statherm pure graphite or mica gasket materials are all available in sheet form or cut gaskets.



Spiral wound gasket

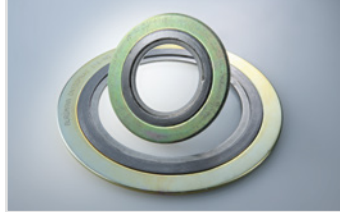

Spiraltherm gaskets are available to suit all pipe flange sizes and machined equipment grooves. Manufactured in accordance with relevant DIN and ANSI standards in all material combinations.

Kammprofile gaskets

Kammprofiles are available to suit all flange connections. Manufactured in accordance with relevant DIN and ANSI standards in all material combinations.



Ring type joints



Buralloy RTJ's are available to suit all ANSI pipe flange sizes in all materials from soft iron up to exotic alloys. The joints are manufactured to API 6A standards with full quality assurance certification.

Heat exchanger gaskets

Buralloy metal jacketed gaskets can be manufactured to drawing to suit all forms of heat exchanger and process equipment flange connections. These gaskets can be manufactured with fiber or metal inserts as required.



Expanded PTFE tapes and sealants



A full range of Burachem Quick-Seal expanded PTFE sealant tapes is available for all forms of in-place gasket requirements. The filled expanded PTFE Cellflon tapes provide a unique combination of adaptability and strength.

TotalSealCare The modular seal service from EagleBurgmann



Are you planning an overhaul of your plant? Perhaps you have a deadline for an upgrade or conversion of all valves to meet fugitive emission regulations, for example. You need more engineers and qualified technical staff? This is where EagleBurgmann can help you – with our mobile on-site sealing service. You describe the scope of work and EagleBurgmann will organise a complete seal workshop to be delivered to site with all the required tools, men, and materials. All managed by an experienced EagleBurgmann site engineer. To make sure that everything goes according to your timetable.

The benefits to you are

- Our knowledge and experience in all matters to do with seals.
- Planning and keeping to budget.
- No extra storage required.
- Quickest seal supply.
- No additional staff of your own required.
- Sealing solutions installed are the latest technology and in compliance with the relevant statutory provisions.
- Site independent due to own mobile service workshop.

Argentina · Australia · Austria · Belarus · Belgium · Bulgaria · Brazil · Canada · Chile · China · Colombia · Cyprus · Czech Republic · Denmark · Ecuador · Egypt · Estonia
Finland · France · Germany · Great Britain · Greece · Hungary · India · Indonesia · Iraq · Israel · Italy · Japan · Jordan · Kazakhstan · Korea · Kuwait · Latvia · Libya · Lithuania
Malaysia · Mauritius · Mexico · Morocco · Myanmar · Netherlands · New Zealand · Nigeria · Norway · Oman · Pakistan · Paraguay · Peru · Philippines · Poland · Qatar
Romania · Russia · Saudi Arabia · Singapore · Slovenia · Slovak Republic · South Africa · Spain · Sweden · Switzerland · Syria · Taiwan · Thailand · Trinidad and Tobago · Tunisia
Turkey · Turkmenistan · Ukraine · United Arab Emirates · Uruguay · USA · Uzbekistan · Venezuela · Vietnam · www.eagleburgmann.com/world



CPE / E3 / 5.000 / 06.13 / 19.41 © Group Marketing, Germany

EagleBurgmann is one of the internationally leading companies for industrial sealing technology. Our products are used everywhere where safety and reliability are important: in the oil and gas industry, refining technology, the petrochemical, chemical and pharmaceutical industries, food processing, power, water, mining, pulp & paper, aerospace and many other spheres. Every day, more than 6,000 employees contribute their ideas, solutions and commitment towards ensuring that customers all over the world can rely on our seals. Our modular TotalSealCare service underlines our strong customer orientation and offers tailor-made services for every application.

eagleburgmann.com

info@eagleburgmann.com

EagleBurgmann®

Rely on excellence