



# Identifikacija Kardanskega križa



Simon Krašna / [simon@bell.si](mailto:simon@bell.si)  
Tel: 02-6296937 / fax: 02-6292120

## Zunanje varovanje

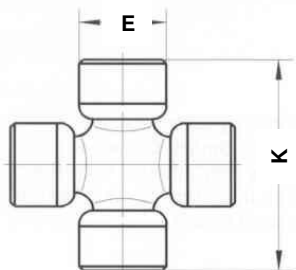

E = Ø mm \_\_\_\_\_

K = mm \_\_\_\_\_

Mazanje št. \_\_\_\_\_

Znamka vozila \_\_\_\_\_

Tip \_\_\_\_\_

Original kat. št. \_\_\_\_\_

## Zunanje varovanje asimetrični

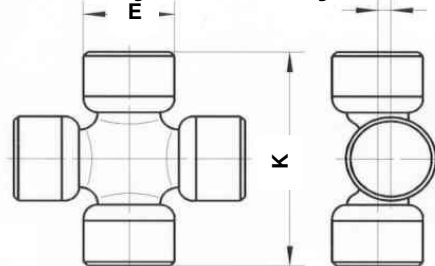

E = Ø mm \_\_\_\_\_

K = mm \_\_\_\_\_

F = mm \_\_\_\_\_

Mazanje št. \_\_\_\_\_

Vozilo znamka \_\_\_\_\_

Tip \_\_\_\_\_

Original kat. št. \_\_\_\_\_

## Notranje varovanje

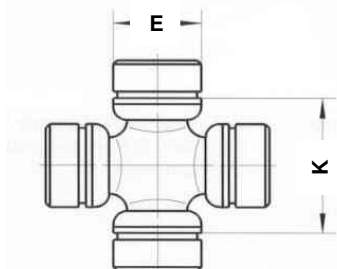

E = Ø \_\_\_\_\_

K = mm \_\_\_\_\_

Mazanje št. \_\_\_\_\_

Vozilo znamka \_\_\_\_\_

Tip \_\_\_\_\_

Original kat. št. \_\_\_\_\_

## KRIŽ "MECHANICS"

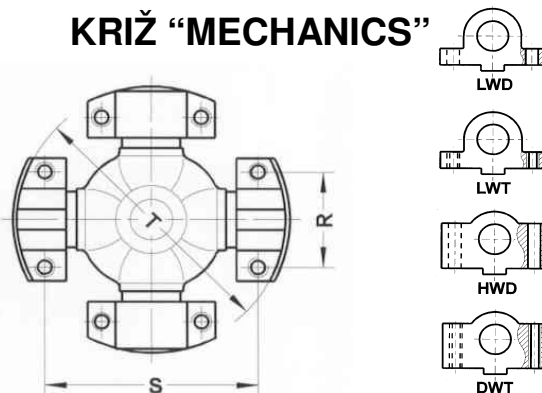

R = mm \_\_\_\_\_

S = mm \_\_\_\_\_

T = mm \_\_\_\_\_

Mazanje št. \_\_\_\_\_

Način vpetja \_\_\_\_\_

Vozilo znamka \_\_\_\_\_

Original kat. št. \_\_\_\_\_

## Mazanje (št.):

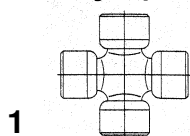

1

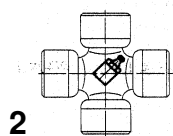

2

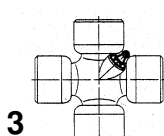

3

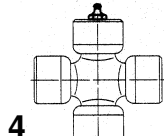

4

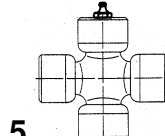

5

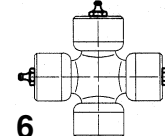

6